

## 12-BITS, 125/105/80/65 MSPS ADC WITH DDR LVDS/CMOS OUTPUTS

### FEATURES

- **Maximum Sample Rate: 125 MSPS**
- **12-Bit Resolution with No Missing Codes**
- **3.5 dB Coarse Gain and up to 6 dB Programmable Fine Gain for SNR/SFDR Trade-Off**
- **Parallel CMOS and Double Data Rate (DDR) LVDS Output Options**
- **Supports Sine, LVCMOS, LVPECL, LVDS Clock Inputs and Clock Amplitude Down to 400 mV<sub>PP</sub>**
- **Clock Duty Cycle Stabilizer**
- **Internal Reference with Support for External Reference**
- **No External Decoupling Required for References**
- **Programmable Output Clock Position and Drive Strength to Ease Data Capture**
- **3.3 V Analog and 1.8 V to 3.3 V Digital Supply**
- **32-QFN Package (5 mm × 5 mm)**
- **Pin Compatible 12-Bit Family (ADS612X)**

### APPLICATIONS

- **Wireless Communications Infrastructure**
- **Software Defined Radio**
- **Power Amplifier Linearization**
- **802.16d/e**
- **Test and Measurement Instrumentation**
- **High Definition Video**
- **Medical Imaging**
- **Radar Systems**

### DESCRIPTION

ADS6125/ADS6124/ADS6123/ADS6122 (ADS612X) is a family of 12-bit A/D converters with sampling frequencies up to 125 MSPS. It combines high performance and low power consumption in a compact 32 QFN package. Using an internal high bandwidth sample and hold and a low jitter clock buffer helps to achieve high SNR and high SFDR even at high input frequencies.

It features coarse and fine gain options that are used to improve SFDR performance at lower full-scale analog input ranges.

The digital data outputs are either parallel CMOS or DDR LVDS (Double Data Rate). Several features exist to ease data capture such as — controls for output clock position and output buffer drive strength, and LVDS current and internal termination programmability.

The output interface type, gain, and other functions are programmed using a 3-wire serial interface. Alternatively, some of these functions are configured using dedicated parallel pins so that the device comes up in the desired state after power-up.

ADS612X includes internal references, while eliminating the traditional reference pins and associated external decoupling. External reference mode is also supported.

The devices are specified over the industrial temperature range (–40°C to 85°C).

**ADS612X Performance Summary**

		<b>ADS6125</b>	<b>ADS6124</b>	<b>ADS6123</b>	<b>ADS6122</b>
<b>SFDR, dBc</b>	$F_{in} = 10 \text{ MHz (0 dB gain)}$	90	91	93	95
	$F_{in} = 170 \text{ MHz (3.5 dB gain)}$	78	82	83	84
<b>SINAD, dBFS</b>	$F_{in} = 10 \text{ MHz (0 dB gain)}$	71.1	71.3	71.5	71.6
	$F_{in} = 170 \text{ MHz (3.5 dB gain)}$	67.6	69.1	69.2	69.8
<b>Power, mW</b>		417	374	318	285



Please be aware that an important notice concerning availability, standard warranty, and use in critical applications of Texas Instruments semiconductor products and disclaimers thereto appears at the end of this data sheet.



This integrated circuit can be damaged by ESD. Texas Instruments recommends that all integrated circuits be handled with appropriate precautions. Failure to observe proper handling and installation procedures can cause damage.

ESD damage can range from subtle performance degradation to complete device failure. Precision integrated circuits may be more susceptible to damage because very small parametric changes could cause the device not to meet its published specifications.

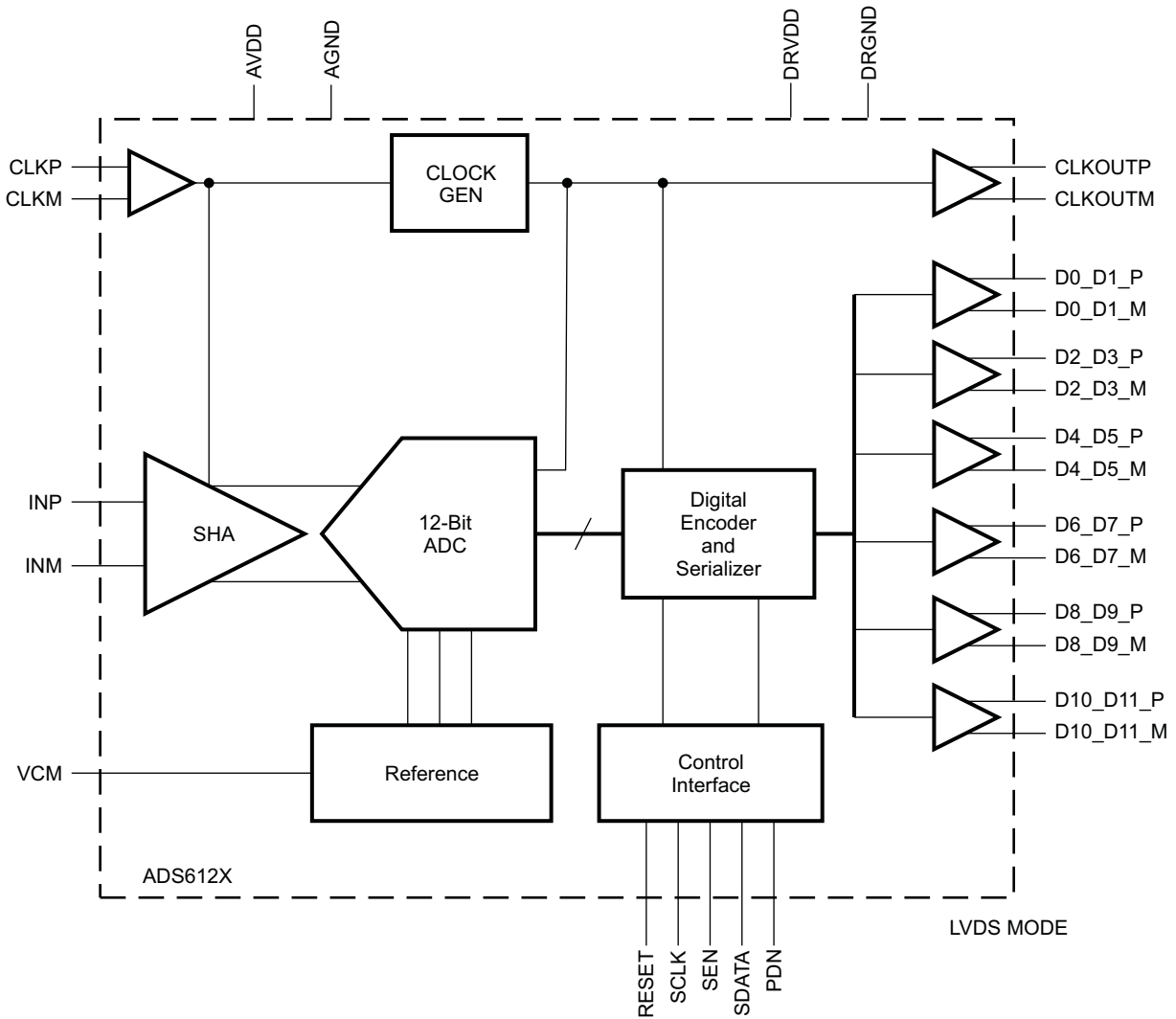

**ADS61XX FAMILY**

	<b>125 MSPS</b>	<b>105 MSPS</b>	<b>80 MSPS</b>	<b>65 MSPS</b>
<b>ADS614X</b> 14 Bits	ADS6145	ADS6144	ADS6143	ADS6142
<b>ADS612X</b> 12 Bits	ADS6125	ADS6124	ADS6123	ADS6122

**PACKAGE/ORDERING INFORMATION<sup>(1)</sup>**

PRODUCT	PACKAGE-LEAD	PACKAGE DESIGNATOR	SPECIFIED TEMPERATURE RANGE	PACKAGE MARKING	ORDERING NUMBER	TRANSPORT MEDIA
ADS6125	QFN-32 <sup>(2)</sup>	RHB	-40°C to 85°C	AZ6125	ADS6125IRHBT	Tape and Reel, small
					ADS6125IRHBR	Tape and Reel, large
ADS6124	QFN-32 <sup>(2)</sup>	RHB	-40°C to 85°C	AZ6124	ADS6124IRHBT	Tape and Reel, small
					ADS6124IRHBR	Tape and Reel, large
ADS6123	QFN-32 <sup>(2)</sup>	RHB	-40°C to 85°C	AZ6123	ADS6123IRHBT	Tape and Reel, small
					ADS6123IRHBR	Tape and Reel, large
ADS6122	QFN-32 <sup>(2)</sup>	RHB	-40°C to 85°C	AZ6122	ADS6122IRHBT	Tape and Reel, small
					ADS6122IRHBR	Tape and Reel, large

- (1) For the most current package and ordering information, see the Package Option Addendum at the end of this document, or see the TI website at [www.ti.com](http://www.ti.com).
- (2) For thermal pad size on the package, see the mechanical drawings at the end of this data sheet.  $\theta_{JA} = 34 \text{ }^\circ\text{C/W}$  (0 LFM air flow),  $\theta_{JC} = 30 \text{ }^\circ\text{C/W}$  when used with 2 oz. copper trace and pad soldered directly to a JEDEC standard four layer 3 in × 3 in (7.62 cm × 7.62 cm) PCB.

**ABSOLUTE MAXIMUM RATINGS<sup>(1)</sup>**

		VALUE	UNIT
$V_I$	Supply voltage range, AVDD	-0.3 to 3.9	V
	Supply voltage range, DRVDD	-0.3 to 3.9	V
	Voltage between AGND and DRGND	-0.3 to 0.3	V
	Voltage between AVDD to DRVDD	-0.3 to 3.3	V
	Voltage applied to VCM pin (in external reference mode)	-0.3 to 2	V
	Voltage applied to analog input pins, INP and INM	-0.3 to minimum ( 3.6, AVDD + 0.3)	V
	Voltage applied to analog input pins, CLKP and CLKM	-0.3 to (AVDD + 0.3)	V
$T_A$	Operating free-air temperature range	-40 to 85	°C
$T_J$	Operating junction temperature range	125	°C
$T_{stg}$	Storage temperature range	-65 to 150	°C

- (1) Stresses beyond those listed under *absolute maximum ratings* may cause permanent damage to the device. These are stress ratings only, and functional operation of the device at these or any other conditions beyond those indicated under *recommended operating conditions* is not implied. Exposure to absolute-maximum-rated conditions for extended periods may affect device reliability.

## RECOMMENDED OPERATING CONDITIONS

over operating free-air temperature range (unless otherwise noted)

		MIN	NOM	MAX	UNIT	
<b>SUPPLIES</b>						
AVDD	Analog supply voltage	3	3.3	3.6	V	
DRVDD	Output buffer supply voltage <sup>(1)</sup>	CMOS Interface	1.65	1.8 to 3.3	3.6	V
		LVDS Interface	3	3.3	3.6	V
<b>ANALOG INPUTS</b>						
	Differential input voltage range		2		V <sub>pp</sub>	
V <sub>IC</sub>	Input common-mode voltage		1.5 ± 0.1		V	
	Voltage applied on VCM in external reference mode	1.45	1.5	1.55	V	
<b>CLOCK INPUT</b>						
F <sub>S</sub>	Input clock sample rate	ADS6125	1	125	MSPS	
		ADS6124	1	105		
		ADS6123	1	80		
		ADS6122	1	65		
	Input clock amplitude differential (V <sub>CLKP</sub> – V <sub>CLKM</sub> )	Sine wave, ac-Coupled	0.4	1.5	V <sub>pp</sub>	
		LVPECL, ac-Coupled		± 0.8		
		LVDS, ac-Coupled		± 0.35		
		LVC MOS, ac-Coupled		3.3		
	Input Clock duty cycle	35%	50%	65%		
<b>DIGITAL OUTPUTS</b>						
	Output buffer drive strength <sup>(2)</sup>	For C <sub>LOAD</sub> ≤ 5 pF and DRVDD ≥ 2.2 V	DEFAULT strength			
		For C <sub>LOAD</sub> > 5 pF and DRVDD ≥ 2.2 V	MAXIMUM strength			
		For DRVDD < 2.2 V	MAXIMUM strength			
C <sub>LOAD</sub>	Maximum external load capacitance from each output pin to DRGND	CMOS Interface, maximum buffer strength	10		pF	
		LVDS Interface, without internal termination	5			
		LVDS Interface, with internal termination	10			
R <sub>LOAD</sub>	Differential load resistance (external) between the LVDS output pairs		100		Ω	
T <sub>A</sub>	Operating free-air temperature		-40	85	°C	

(1) For easy migration to next generation, higher sampling speed devices (> 125 MSPS), use 1.8V DRVDD supply.

(2) See [Output Buffer Strength Programmability](#) in application section

## ELECTRICAL CHARACTERISTICS

Typical values are at 25°C, min and max values are across the full temperature range  $T_{MIN} = -40^{\circ}\text{C}$  to  $T_{MAX} = 85^{\circ}\text{C}$ ,  $AVDD = DRVDD = 3.3\text{ V}$ , maximum rated sampling frequency, 50% clock duty cycle, -1 dBFS differential analog input, internal reference mode, applies to CMOS and LVDS interfaces, unless otherwise noted.

PARAMETER	ADS6125 $F_S = 125\text{ MSPS}$			ADS6124 $F_S = 105\text{ MSPS}$			ADS6123 $F_S = 80\text{ MSPS}$			ADS6122 $F_S = 65\text{ MSPS}$			UNIT
	MIN	TYP	MAX	MIN	TYP	MAX	MIN	TYP	MAX	MIN	TYP	MAX	
RESOLUTION	12			12			12			12			Bits
<b>ANALOG INPUT</b>													
Differential input voltage range	2			2			2			2			$V_{PP}$
Differential input resistance (at dc) see Figure 91	> 1			> 1			> 1			> 1			$M\Omega$
Differential input capacitance see Figure 92	7			7			7			7			pF
Analog input bandwidth	450			450			450			450			MHz
Analog input common mode current (per input pin of each ADC)	180			151			114			92			$\mu\text{A}$
<b>REFERENCE VOLTAGES</b>													
VREFB Internal reference bottom voltage	1			1			1			1			V
VREFT Internal reference top voltage	2			2			2			2			V
$\Delta V_{REF}$ Internal reference error (VREFT-VREFB)	-20	$\pm 5$	20	-20	$\pm 5$	20	-20	$\pm 5$	20	-20	$\pm 5$	20	mV
$V_{CM}$ Common mode output voltage	1.5			1.5			1.5			1.5			V
<b>DC ACCURACY</b>													
No missing codes	Specified			Specified			Specified			Specified			
$E_O$ Offset error	-10	$\pm 2$	10	-10	$\pm 2$	10	-10	$\pm 2$	10	-10	$\pm 2$	10	mV
Offset error temperature coefficient	0.05			0.05			0.05			0.05			$\text{mV}/^{\circ}\text{C}$
There are two sources of gain error – internal reference inaccuracy and channel gain error													
$E_{GREF}$ Gain error due to internal reference inaccuracy alone, ( $\Delta V_{REF}/2$ ) %	-1	0.25	1	-1	0.25	1	-1	0.25	1	-1	0.25	1	% FS
$E_{GCHAN}$ Gain error of channel alone <sup>(1)</sup>	-1	$\pm 0.3$	1	-1	$\pm 0.3$	1	-1	$\pm 0.3$	1	-1	$\pm 0.3$	1	% FS
Channel gain error temperature coefficient	0.005			0.005			0.005			0.005			$\Delta\%/^{\circ}\text{C}$
DNL Differential nonlinearity	-0.75	$\pm 0.6$	2	-0.75	$\pm 0.6$	2	-0.75	$\pm 0.5$	2	-0.75	$\pm 0.5$	2	LSB
INL Integral nonlinearity	-2	$\pm 1$	2	-2	$\pm 1$	2	-2	$\pm 1$	2	-2	$\pm 1$	2	LSB
<b>POWER SUPPLY</b>													
$I_{AVDD}$ Analog supply current	123			110			94			84			mA
$I_{DRVDD}$ Digital supply current, <b>CMOS</b> interface DRVDD = 1.8 V No load capacitance, $F_{IN} = 2\text{ MHz}$ <sup>(2)</sup>	6.1			5.4			4.5			4.0			mA
$I_{DRVDD}$ Digital supply current, <b>LVDS</b> interface DRVDD = 3.3 V With 100 $\Omega$ external termination	42			42			42			42			mA
Total power, <b>CMOS</b>	417		625	374		525	318		440	285		400	mW
Global power down	30		60	30		60	30		60	30		60	mW

(1) This is specified by design and characterization; it is not tested in production.

(2) In CMOS mode, the DRVDD current scales with the sampling frequency and the load capacitance on output pins (see Figure 84).

**ELECTRICAL CHARACTERISTICS**

Typical values are at 25°C, min and max values are across the full temperature range  $T_{MIN} = -40^{\circ}C$  to  $T_{MAX} = 85^{\circ}C$ ,  $AVDD = DRVDD = 3.3 V$ , maximum rated sampling frequency, 50% clock duty cycle, -1 dBFS differential analog input, internal reference mode, applies to CMOS and LVDS interfaces, unless otherwise noted.

PARAMETER	TEST CONDITIONS	ADS6125 F <sub>S</sub> = 125 MSPS			ADS6124 F <sub>S</sub> = 105 MSPS			ADS6123 F <sub>S</sub> = 80 MSPS			ADS6122 F <sub>S</sub> = 65 MSPS			UNIT
		MIN	TYP	MAX	MIN	TYP	MAX	MIN	TYP	MAX	MIN	TYP	MAX	
<b>DYNAMIC AC CHARACTERISTICS</b>														
SNR Signal to noise ratio, <b>CMOS</b>	Fin = 10 MHz		71.3		71.4		71.6		71.7				dBFS	
	Fin = 50 MHz		68.5	71.1		71.1		69	71.4			71.5		
	Fin = 70 MHz			70.9		68.5	71		71.3		69	71.5		
	Fin = 170 MHz	0 dB Gain		69.5			70		70.3			70.6		
		3.5 dB Coarse gain		68.7			69.4		69.7			69.9		
	Fin = 230 MHz	0 dB Gain		68.6			69.2		69.6			69.9		
3.5 dB Coarse gain			67.9			68.6		69.1			69.4			
SNR Signal to noise ratio, <b>LVDS</b>	Fin = 10 MHz		71.5		71.5		71.8		71.8				dBFS	
	Fin = 50 MHz		68.5	71.4		71.3		69	71.5			71.6		
	Fin = 70 MHz			71.3		68.5	71.3		71.5		69	71.6		
	Fin = 170 MHz	0 dB Gain		70.3			70.3		70.6			70.7		
		3.5 dB Coarse gain		69.8			69.8		70.1			70.1		
	Fin = 230 MHz	0 dB Gain		69.6			69.6		70			70.1		
3.5 dB Coarse gain			69			69		69.5			69.6			
SINAD Signal to noise and distortion ratio <b>CMOS</b>	Fin = 10 MHz		71.1		71.3		71.5		71.6				dBFS	
	Fin = 50 MHz		68	70.3		70.7		68.5	71.3			71.4		
	Fin = 70 MHz			70.4		68	70.9		70.9		68.5	71.4		
	Fin = 170 MHz	0 dB Gain		67.7			69.5		69.6			70.2		
		3.5 dB Coarse gain		67.6			69.1		69.2			69.8		
	Fin = 230 MHz	0 dB Gain		66.6			68		68.9			69.1		
3.5 dB Coarse gain			66.3			68		68.6			69			
SINAD Signal to noise and distortion ratio <b>LVDS</b>	Fin = 10 MHz		71.5		71.5		71.7		71.7				dBFS	
	Fin = 50 MHz		70.6		70.7		71.4		71.5			71.5		
	Fin = 70 MHz			71		71		71.1				71.5		
	Fin = 170 MHz	0 dB Gain		69.1			69.7		70.1			70.3		
		3.5 dB Coarse gain		69.3			69.5		69.9			70		
	Fin = 230 MHz	0 dB Gain		68.2			68.1		69.4			69.1		
3.5 dB Coarse gain			68.3			68.3		69.2			69.1			
ENOB Effective number of bits	Fin = 50 MHz		11	11.4				11	11.55				Bits	
	Fin = 70 MHz					11	11.5				11	11.56		
SFDR Spurious free dynamic range	Fin = 10 MHz		90		91		93		95				dBc	
	Fin = 50 MHz		76	80		83		79	89			89		
	Fin = 70 MHz			84		76	84		84		79	86		
	Fin = 170 MHz	0 dB Gain		76			80		81			82		
		3.5 dB Coarse gain		78			82		83			84		
	Fin = 230 MHz	0 dB Gain		75			77		79			79		
3.5 dB Coarse gain			76			79		81			82			

## ELECTRICAL CHARACTERISTICS (continued)

Typical values are at 25°C, min and max values are across the full temperature range  $T_{MIN} = -40^{\circ}\text{C}$  to  $T_{MAX} = 85^{\circ}\text{C}$ ,  $AVDD = DRVDD = 3.3\text{ V}$ , maximum rated sampling frequency, 50% clock duty cycle,  $-1\text{ dBFS}$  differential analog input, internal reference mode, applies to CMOS and LVDS interfaces, unless otherwise noted.

PARAMETER	TEST CONDITIONS		ADS6125 $F_S = 125\text{ MSPS}$			ADS6124 $F_S = 105\text{ MSPS}$			ADS6123 $F_S = 80\text{ MSPS}$			ADS6122 $F_S = 65\text{ MSPS}$			UNIT	
			MIN	TYP	MAX	MIN	TYP	MAX	MIN	TYP	MAX	MIN	TYP	MAX		
THD Total harmonic distortion	Fin = 10 MHz		88.5			90			91.5			93			dBc	
	Fin = 50 MHz		73	79.5		82.5			76	88		88				
	Fin = 70 MHz		82			73	83		83			76	85			
	Fin = 170 MHz	0 dB Gain		73.5			79			78			80			
		3.5 dB Coarse gain		75			81			79			82			
	Fin = 230 MHz	0 dB Gain		71.5			75.5			76			76			
3.5 dB Coarse gain			72.5			77.5			78			78.5				
HD2 Second harmonic distortion	Fin = 10 MHz		96			96			97			98			dBc	
	Fin = 50 MHz		76	95		96			79	96		96				
	Fin = 70 MHz		91			76	92		93			79	93			
	Fin = 170 MHz	0 dB Gain		81			83			83			86			
		3.5 dB Coarse gain		82			84			84			87			
	Fin = 230 MHz	0 dB Gain		75			79			80			79			
3.5 dB Coarse gain			76			81			81			81				
HD3 Third harmonic distortion	Fin = 10 MHz		90			91			93			95			dBc	
	Fin = 50 MHz		76	80		83			79	89		89				
	Fin = 70 MHz		84			76	84		84			79	86			
	Fin = 170 MHz	0 dB Gain		76			80			81			82			
		3.5 dB Coarse gain		78			82			83			84			
	Fin = 230 MHz	0 dB Gain		75			77			79			79			
3.5 dB Coarse gain			76			79			81			82				
Worst spur (Other than HD2, HD3)	Fin = 10 MHz		93			94			96			97			dBc	
	Fin = 50 MHz		92			90			93			96				
	Fin = 70 MHz		91			90			92			95				
	Fin = 170 MHz		90			89			89			91				
	Fin = 230 MHz		90			88			89			90				
IMD 2-Tone intermodulation distortion	F1 = 185 MHz, F2 = 190 MHz Each tone at $-7\text{ dBFS}$		83			82			84			88			dBFS	
Input overload recovery	Recovery to within 1% (of final value) for 6-dB overload with sine wave input		1			1			1			1			clock cycles	
PSRR AC Power supply rejection ratio	For 100 mVpp signal on AVDD supply		35			35			35			35			dBc	

## DIGITAL CHARACTERISTICS<sup>(1)</sup>

The DC specifications refer to the condition where the digital outputs are not switching, but are permanently at a valid logic level 0 or 1 AVDD = 3.3 V

PARAMETER	TEST CONDITIONS	ADS6125/ADS6124 ADS6123/ADS6122			UNIT
		MIN	TYP	MAX	
<b>DIGITAL INPUTS PDN, SCLK, SEN &amp; SDATA<sup>(2)</sup></b>					
High-level input voltage		2.4			V
Low-level input voltage				0.8	V
High-level input current			33		μA
Low-level input current			-33		μA
Input capacitance			4		pF
<b>DIGITAL OUTPUTS CMOS INTERFACE, DRVDD = 1.8 to 3.3 V</b>					
High-level output voltage			DRVDD		V
Low-level output voltage			0		V
Output capacitance	Output capacitance inside the device, from each output to ground		2		pF
<b>DIGITAL OUTPUTS LVDS INTERFACE, DRVDD = 3.3 V, I<sub>O</sub> = 3.5 mA, R<sub>L</sub> = 100 Ω<sup>(3)</sup></b>					
High-level output voltage			1375		mV
Low-level output voltage			1025		mV
Output differential voltage,  V <sub>OD</sub>		225	350		mV
V <sub>OS</sub> Output offset voltage, single-ended	Common-mode voltage of OOTP, OUTM		1200		mV
Output capacitance	Output capacitance inside the device, from either output to ground		2		pF

- (1) All LVDS and CMOS specifications are characterized, but not tested at production.  
(2) SCLK & SEN function as digital input pins when they are used for serial interface programming. When used as parallel control pins, analog voltage needs to be applied as per [Table 1](#) & [Table 2](#).  
(3) I<sub>O</sub> Refers to the LVDS buffer current setting, R<sub>L</sub> is the differential load resistance between the LVDS output pair.



## TIMING CHARACTERISTICS – LVDS AND CMOS MODES<sup>(1)</sup>

Typical values are at 25°C, min and max values are across the full temperature range  $T_{MIN} = -40^{\circ}\text{C}$  to  $T_{MAX} = 85^{\circ}\text{C}$ ,  $AVDD = DRVDD = 3.3\text{ V}$ , maximum rated sampling frequency, sine wave input clock, 1.5  $V_{PP}$  clock amplitude,  $C_L = 5\text{ pF}^{(2)}$ ,  $I_O = 3.5\text{ mA}$ ,  $R_L = 100\ \Omega$ <sup>(3)</sup>, no internal termination, unless otherwise noted.

For timings at lower sampling frequencies, see section [Output Timings](#) in the APPLICATION INFORMATION of this data sheet.

PARAMETER	TEST CONDITIONS	ADS6125 $F_s = 125\text{ MSPS}$			ADS6124 $F_s = 105\text{ MSPS}$			ADS6123 $F_s = 80\text{ MSPS}$			ADS6122 $F_s = 65\text{ MSPS}$			UNIT
		MIN	TYP	MAX	MIN	TYP	MAX	MIN	TYP	MAX	MIN	TYP	MAX	
$t_a$	Aperture delay	0.7	1.5	2.5	0.7	1.5	2.5	0.7	1.5	2.5	0.7	1.5	2.5	ns
$t_j$	Aperture jitter	150			150			150			150			fs rms
Wake-up time (to valid data)	From global power down	15 50			15 50			15 50			15 50			$\mu\text{s}$
	From standby	15 50			15 50			15 50			15 50			$\mu\text{s}$
	From output buffer disable	CMOS	100	200	100	200	100	200	100	200	100	200	ns	
		LVDS	200	500	200	500	200	500	200	500	200	500	ns	
Latency		9			9			9			9			clock cycles
<b>DDR LVDS MODE<sup>(4)</sup>, <math>DRVDD = 3.3\text{ V}</math></b>														
$t_{su}$	Data setup time <sup>(5)</sup>	Data valid <sup>(6)</sup> to zero-cross of CLKOUTP			1.7	2.3	2.5	3.1	3.9	4.5	5.4	6.0	ns	
$t_h$	Data hold time <sup>(5)</sup>	Zero-cross of CLKOUTP to data becoming invalid <sup>(6)</sup>			0.7	1.7	0.7	1.7	0.7	1.7	0.7	1.7	ns	
$t_{PDI}$	Clock propagation delay	Input clock rising edge zero-cross to output clock rising edge zero-cross			4.3	5.8	7.3	4.3	5.8	7.3	4.3	5.8	7.3	ns
	LVDS bit clock duty cycle	Duty cycle of differential clock, (CLKOUTP-CLKOUTM) $10 \leq F_s \leq 125\text{ MSPS}$			40%	47%	55%	40%	47%	55%	40%	47%	55%	
$t_r$ $t_f$	Data rise time, Data fall time	Rise time measured from $-50\text{ mV}$ to $50\text{ mV}$ Fall time measured from $50\text{ mV}$ to $-50\text{ mV}$ $1 \leq F_s \leq 125\text{ MSPS}$			70	100	170	70	100	170	70	100	170	ps
$t_{CLKRI}$ $t_{CLKFALL}$	Output clock rise time, Output clock fall time	Rise time measured from $-50\text{ mV}$ to $50\text{ mV}$ Fall time measured from $50\text{ mV}$ to $-50\text{ mV}$ $1 \leq F_s \leq 125\text{ MSPS}$			70	100	170	70	100	170	70	100	170	ps
<b>PARALLEL CMOS MODE, <math>DRVDD = 2.5\text{ V}</math> to <math>3.3\text{ V}</math>, default output buffer drive strength<sup>(7)</sup></b>														
$t_{su}$	Data setup time <sup>(5)</sup>	Data valid <sup>(8)</sup> to 50% of CLKOUT rising edge			2.9	4.4	3.6	5.1	5.1	6.6	6.5	8.0	ns	
$t_h$	Data hold time <sup>(5)</sup>	50% of CLKOUT Rising edge to data becoming invalid <sup>(8)</sup>			1.3	2.7	2.1	3.5	3.6	5.0	5.1	6.5	ns	
$t_{PDI}$	Clock propagation delay	Input clock rising edge zero-cross to 50% of CLKOUT rising edge			5	6.5	7.9	5	6.5	7.9	5	6.5	7.9	ns

(1) Timing parameters are specified by design and characterization and not tested in production.

(2)  $C_L$  is the Effective external single-ended load capacitance between each output pin and ground.

(3)  $I_O$  Refers to the LVDS buffer current setting;  $R_L$  is the differential load resistance between the LVDS output pair.

(4) Measurements are done with a transmission line of  $100\ \Omega$  characteristic impedance between the device and the load.

(5) Setup and hold time specifications take into account the effect of jitter on the output data and clock.

(6) Data valid refers to logic high of  $+100\text{ mV}$  and logic low of  $-100\text{ mV}$ .

(7) For  $DRVDD < 2.2\text{ V}$ , it is recommended to use external clock for data capture and NOT the device output clock signal (CLKOUT). See [Parallel CMOS interface](#) in application section.

(8) Data valid refers to logic high of  $2\text{ V}$  ( $1.7\text{ V}$ ) and logic low of  $0.8\text{ V}$  ( $0.7\text{ V}$ ) for  $DRVDD = 3.3\text{ V}$  ( $2.5\text{ V}$ ).

**TIMING CHARACTERISTICS – LVDS AND CMOS MODES (continued)**

For timings at lower sampling frequencies, see section [Output Timings](#) in the APPLICATION INFORMATION of this data sheet.

PARAMETER	TEST CONDITIONS	ADS6125 F <sub>s</sub> = 125 MSPS			ADS6124 F <sub>s</sub> = 105 MSPS			ADS6123 F <sub>s</sub> = 80 MSPS			ADS6122 F <sub>s</sub> = 65 MSPS			UNIT
		MIN	TYP	MAX	MIN	TYP	MAX	MIN	TYP	MAX	MIN	TYP	MAX	
Output clock duty cycle	Duty cycle of output clock (CLKOUT) 10 ≤ F <sub>s</sub> ≤ 125 MSPS	45%	50%	55%	45%	50%	55%	45%	50%	55%	45%	50%	55%	
t <sub>r</sub> t <sub>f</sub> Data rise time, Data fall time	Rise time measured from 20% to 80% of DRVDD Fall time measured from 80% to 20% of DRVDD 1 ≤ F <sub>s</sub> ≤ 125 MSPS	0.8	1.5	2.4	0.8	1.5	2.4	0.8	1.5	2.4	0.8	1.5	2.4	ns
t <sub>CLKRISE</sub> t <sub>CLKFALL</sub> Output clock rise time, Output clock fall time	Rise time measured from 20% to 80% of DRVDD Fall time measured from 80% to 20% of DRVDD 1 ≤ F <sub>s</sub> ≤ 125 MSPS	0.8	1.5	2.4	0.8	1.5	2.4	0.8	1.5	2.4	0.8	1.5	2.4	ns

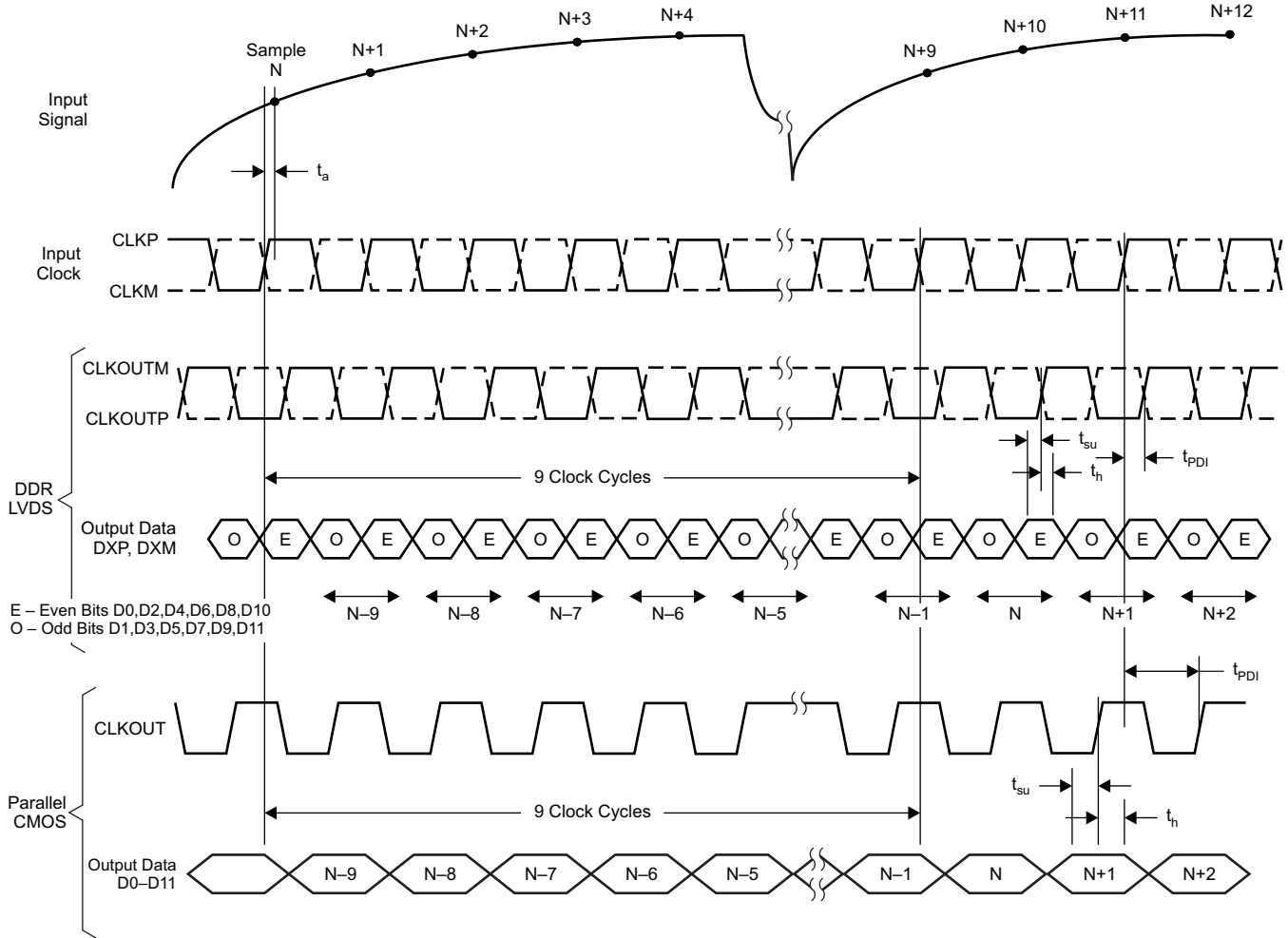
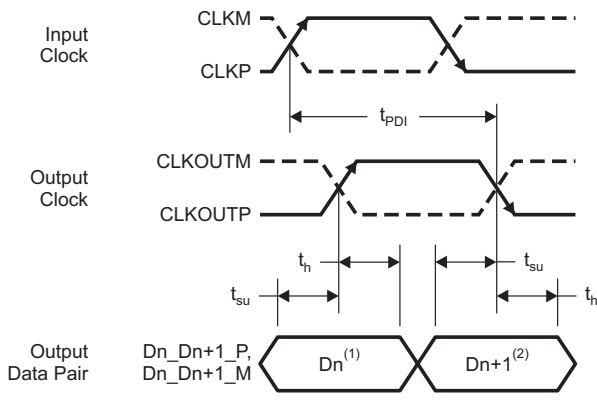

Figure 1. Latency



<sup>(1)</sup>Dn – Bits D0, D2, D4, D6, D8, D10

<sup>(2)</sup>Dn+1 – Bits D1, D3, D5, D7, D9, D11

Figure 2. LVDS Mode Timing

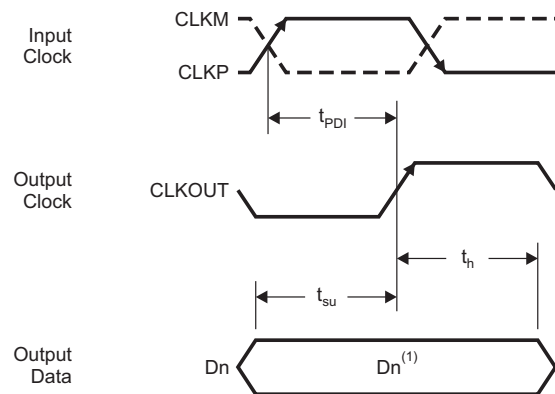

<sup>(1)</sup>Dn – Bits D0–D11

Figure 3. CMOS Mode Timing

## DEVICE PROGRAMMING MODES

ADS612X has several features that can be easily configured using either parallel interface control or serial interface programming.

### USING SERIAL INTERFACE PROGRAMMING ONLY

To program using the serial interface, the internal registers must first be reset to their default values, and the RESET pin must be kept **low**. In this mode, SEN, SDATA, and SCLK function as serial interface pins and are used to access the internal registers of ADC. The registers are reset either by applying a pulse on the RESET pin, or by a **high** setting on the <RST> bit (D4 in register 0x00). The [Serial Interface](#) section describes register programming and register reset in more detail.

### USING PARALLEL INTERFACE CONTROL ONLY

To control the device using parallel interface, keep RESET tied to **high** (AVDD). Now, SEN, SCLK, SDATA and PDN function as parallel interface control pins. These pins can be used to directly control certain modes of the ADC by connecting them to the correct voltage levels (as described in [Table 1](#) to [Table 3](#)). There is no need to apply a reset pulse.

Frequently used functions are controlled in this mode — standby, selection between LVDS/CMOS output format, internal/external reference and 2s complement/straight binary output format. [Table 1](#), [Table 2](#), and [Table 3](#) describe the modes controlled by the parallel pins.

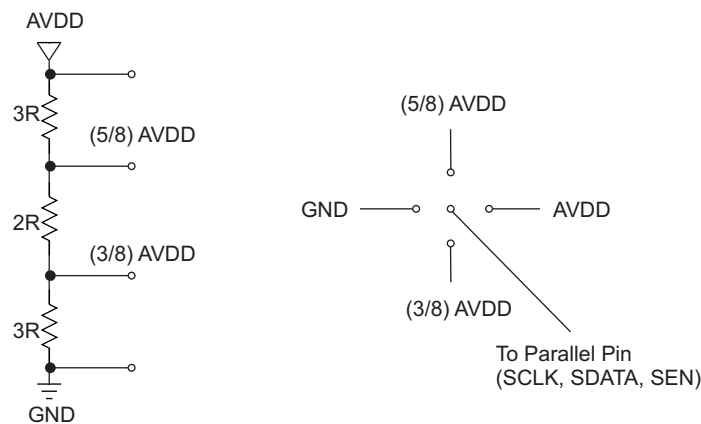

Figure 4. Simple Scheme to Configure Parallel Pins

## DESCRIPTION OF PARALLEL PINS

Table 1. SCLK Control Pin

SCLK	DESCRIPTION
0	Internal reference and 0 dB gain (Full-scale = 2 V <sub>PP</sub> )
(3/8) AVDD	External reference and 0 dB gain (Full-scale = 2 V <sub>PP</sub> )
(5/8) AVDD	External reference and 3.5 dB coarse gain (Full-scale = 1.34 V <sub>PP</sub> )
AVDD	Internal reference and 3.5 dB coarse gain (Full-scale = 1.34 V <sub>PP</sub> )

Table 2. SEN Control Pin

SEN	DESCRIPTION
0	2s Complement format and DDR LVDS interface
(3/8) AVDD	Straight binary format and DDR LVDS interface
(5/8) AVDD	Straight binary and parallel CMOS interface
AVDD	2s Complement format and parallel CMOS interface

**Table 3. SDATA, PDN Control Pins**

SDATA	PDN	DESCRIPTION
Low	Low	Normal operation
Low	High (AVDD)	Standby - only the ADC is powered down
High (AVDD)	Low	Output buffers are powered down, fast wake-up time
High (AVDD)	High (AVDD)	Global power down. ADC, internal reference and output buffers are powered down, slow wake-up time

## SERIAL INTERFACE

The ADC has a set of internal registers, which can be accessed through the serial interface formed by pins SEN (Serial interface Enable), SCLK (Serial Interface Clock), SDATA (Serial Interface Data) and RESET. After device power-up, the internal registers must be reset to their default values by applying a high-going pulse on RESET (of width greater than 10 ns).

Serial shift of bits into the device is enabled when SEN is low. Serial data SDATA is latched at every falling edge of SCLK when SEN is active (low). The serial data is loaded into the register at every 16th SCLK falling edge when SEN is low. If the word length exceeds a multiple of 16 bits, the excess bits are ignored. Data is loaded in multiples of 16-bit words within a single active SEN pulse.

The first 5 bits form the register address and the remaining 11 bits form the register data.

The interface can work with SCLK frequency from 20 MHz down to very low speeds (few Hertz) and also with non-50% SCLK duty cycle.

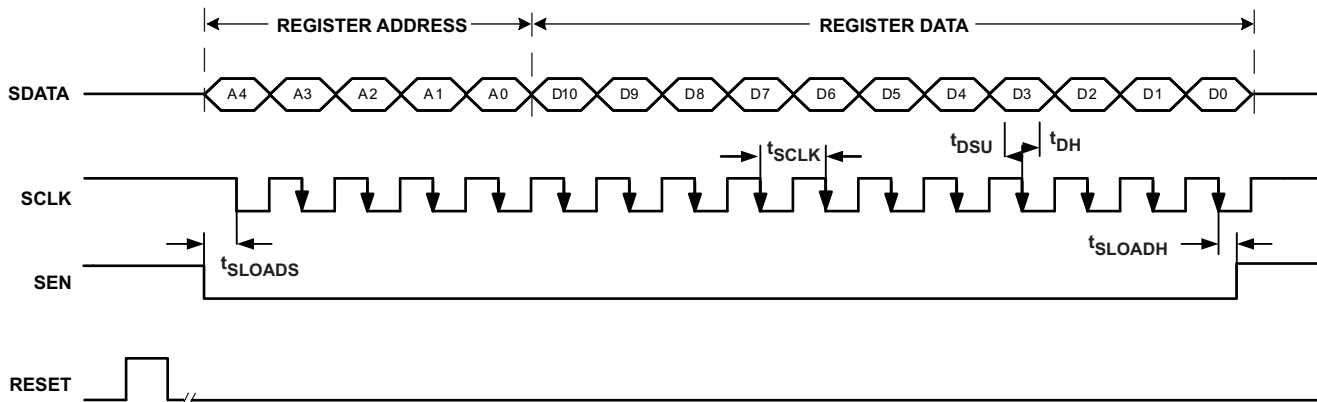

**Figure 5. Serial Interface Timing Diagram**

## REGISTER INITIALIZATION

After power-up, the internal registers *must* be reset to their default values. This is done in one of two ways:

1. Either through hardware reset by applying a high-going pulse on RESET pin (of width greater than 10 ns) as shown in [Figure 5](#).

OR

2. By applying software reset. Using the serial interface, set the <RST> bit (D4 in register 0x00) to **high**. This initializes the internal registers to their default values and then self-resets the <RST> bit to **low**. In this case the RESET pin is kept **low**.

## SERIAL INTERFACE TIMING

Typical values at 25°C, min and max values across the full temperature range  $T_{MIN} = -40^{\circ}\text{C}$  to  $T_{MAX} = 85^{\circ}\text{C}$ ,  
AVDD = DRVDD = 3.3 V (unless otherwise noted)

		MIN	TYP	MAX	UNIT
$f_{SCLK}$	SCLK Frequency = $1/t_{SCLK}$	> DC		20	MHz
$t_{SLOADS}$	SEN to SCLK Setup time	25			ns
$t_{SLOADH}$	SCLK to SEN Hold time	25			ns
$t_{DSU}$	SDATA Setup time	25			ns
$t_{DH}$	SDATA Hold time	25			ns

## RESET TIMING

Typical values at 25°C, min and max values across the full temperature range  $T_{MIN} = -40^{\circ}\text{C}$  to  $T_{MAX} = 85^{\circ}\text{C}$ ,  
AVDD = DRVDD = 3.3 V (unless otherwise noted)

PARAMETER	TEST CONDITIONS	MIN	TYP	MAX	UNIT
$t_1$	Power-on delay	5			ms
$t_2$	Reset pulse width	10			ns
$t_3$	Register write delay	25			ns
$t_{PO}$	Power-up time		6.5		ms

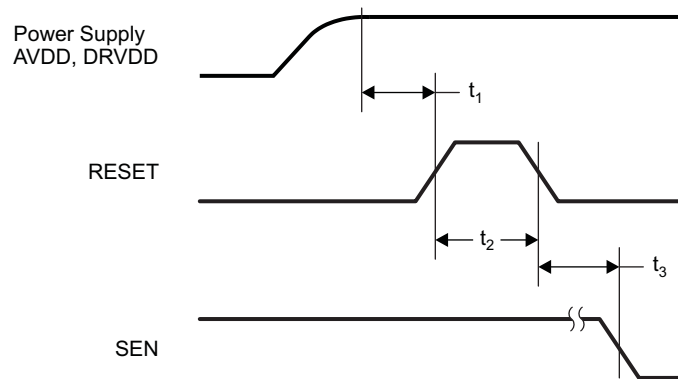

NOTE: A high-going pulse on RESET pin is required in serial interface mode in case of initialization through hardware reset.  
For parallel interface operation, RESET has to be tied permanently HIGH.

Figure 6. Reset Timing Diagram

## SERIAL REGISTER MAP

Table 4 provides a summary of all the modes that can be programmed through the serial interface.

**Table 4. Summary of Functions Supported by Serial Interface<sup>(1)(2)</sup>**

REGISTER ADDRESS IN HEX	REGISTER FUNCTIONS										
	A4 - A0	D10	D9	D8	D7	D6	D5	D4	D3	D2	D1
00	<PDN OBUF> Output buffers powered down	<COARSE GAIN> Coarse gain	<LVDS CMOS> LVDS or CMOS output interface	0	0	<REF> Internal or external Reference	<RST> Software Reset	0	<PDN CLKOUT> Output clock buffer powered down	0	<STBY> ADC Power down
04	<DATAOUT POSN> Output data position control	<CLKOUT EDGE> Output Clock edge control	<CLKOUT POSN> Output Clock position control	0	0	0	0	0	0	0	0
09	Bit-wise or Byte-wise control	0	0	0	0	0	0	0	0	0	0
0A	<DATA FORMAT> 2s complement or straight binary	0	0	<TEST PATTERNS>			0	0	0	0	0
0B	<CUSTOM LOW> Custom Pattern lower 7bits							0	0	0	0
0C	<FINE GAIN> Fine Gain 0 to 6dB				0	0	0	<CUSTOM HIGH> Custom Pattern upper 5 bits			
0E	0	LVDS Termination LVDS Internal Termination control for output data and clock						<LVDS CURRENT> LVDS Current control		<CURRENT DOUBLE> LVDS current double	
0F	0	0	0	<DRIVE STRENGTH> CMOS output buffer drive strength control				0	0	0	0

- (1) The unused bits in each register (shown by blank cells in above table) must be programmed as '0'.  
(2) Multiple functions in a register can be programmed in a single write operation.

## DESCRIPTION OF SERIAL REGISTERS

Each register function is explained in detail below.

**Table 5.**

A4–A0 (hex)	D10	D9	D8	D7	D6	D5	D4	D3	D2	D1	D0
00	<PDN OBUF> Output buffers powered down	<COARSE GAIN> Coarse gain	<LVDS CMOS> LVDS or CMOS output interface	0	0	<REF> Internal or external reference	<RST> Software Reset	0	<PDN CLKOUT> Output clock buffer powered down	0	<STBY> ADC Power down

### D0 <STBY> [Power down modes](#)

- 0 Normal operation
- 1 Device enters standby mode where only ADC is powered down.

### D2 <PDN CLKOUT> [Power down modes](#)

- 0 Output clock is active (on CLKOUT) pin
- 1 Output clock buffer is powered down and becomes tri-stated. Data outputs are unaffected.

### D4 <RST>

- 1 Software reset applied - resets all internal registers and the bit self-clears to 0.

### D5 <REF> [Reference selection](#)

- 0 Internal reference enabled
- 1 External reference enabled

### D8 <LVDS CMOS> [Output Interface selection](#)

- 0 Parallel CMOS interface
- 1 DDR LVDS interface

### D9 <COARSE GAIN> [Gain programming](#)

- 0 0 dB Coarse gain
- 1 3.5 dB Coarse gain

### D10 <PDN OBUF> [Power down modes](#)

- 0 Output data and clock buffers enabled
- 1 Output data and clock buffers disabled



**Table 6.**

A4–A0 (hex)	D10	D9	D8	D7	D6	D5	D4	D3	D2	D1	D0
04	<DATAOUT POSN> Output data position control	<CLKOUT EDGE> Output Clock edge control	<CLKOUT POSN> Output Clock position control	0	0	0	0	0	0	0	0

**D8** <CLKOUT POSN> [Output clock position control](#)

- 0 Default output clock position after reset. The setup/hold timings for this clock position are specified in the timing specifications table.
- 1 Output clock shifted (delayed) by 400 ps

**D9** <CLKOUT EDGE>

- 0 Use rising edge to capture data
- 1 Use falling edge to capture data

**D10** <DATAOUT\_POSN>

- 0 Default position (after reset)
- 1 Data transition delayed by half clock cycle with respect to default position

**Table 7.**

A4–A0 (hex)	D10	D9	D8	D7	D6	D5	D4	D3	D2	D1	D0
09	Bit-wise or Byte-wise control	0	0	0	0	0	0	0	0	0	0

**D10** **Bit-wise or byte-wise selection (DDR LVDS mode only)**

- 0 Bit-wise sequence - Even data bits (D0, D2, D4..D12) are output at rising edge of CLKOUTP and odd data bits (D1, D3, D5..D13) at falling edge of CLKOUTP
- 1 Byte-wise sequence - Lower 7 data bits (D0-D7) are output at rising edge of CLKOUTP and upper 7 data bits (D8-D13) at falling edge of CLKOUTP

**Table 8.**

A4–A0 (hex)	D10	D9	D8	D7	D6	D5	D4	D3	D2	D1	D0
0A	<DF> 2s complement or straight binary	0	0	<TEST PATTERNS>			0	0	0	0	0

**D7-D5 Test Patterns**

- 000 Normal operation - <D13:D0> = ADC output
- 001 All zeros - <D13:D0> = 0x0000
- 010 All ones - <D13:D0> = 0x3FFF
- 011 Toggle pattern - <D13:D0> toggles between 0x2AAA and 0x1555
- 100 Digital ramp - <D13:D0> increments from 0x0000 to 0x3FFF by one code every cycle
- 101 Custom pattern - <D13:D0> = contents of CUSTOM PATTERN registers
- 110 Unused
- 111 Unused

**D10 <DATA FORMAT>**

- 0 2s Complement
- 1 Straight binary

**Table 9.**

A4–A0 (hex)	D10	D9	D8	D7	D6	D5	D4	D3	D2	D1	D0
0B	<CUSTOM LOW> Lower 7bits of custom pattern							0	0	0	0

**Table 10.**

A4–A0 (hex)	D10	D9	D8	D7	D6	D5	D4	D3	D2	D1	D0
0C	<FINE GAIN> Fine Gain 0 to 6dB			0	0	0	<CUSTOM HIGH> Upper 5 bits of custom pattern				

Reg 0B <CUSTOM LOW> - Specifies lower 7 bits of custom pattern  
D10-D4

Reg 0C <CUSTOM HIGH> - Specifies upper 5 bits of custom pattern  
D4-D0

**D10-D8 <FINE GAIN> [Gain programming](#)**

- 000 0 dB Gain
- 001 1 dB Gain
- 010 2 dB Gain
- 011 3 dB Gain
- 100 4 dB Gain
- 101 5 dB Gain
- 110 6 dB Gain
- 111 Unused

**Table 11.**

A4-A0 (hex)	D10	D9	D8	D7	D6	D5	D4	D3	D2	D1	D0
0E	0	<LVDS TERMINATION> LVDS Internal Termination control for output data and clock						<LVDS CURRENT> LVDS Current control		<CURRENT DOUBLE> LVDS current double	

**D1-D0** <CURRENT DOUBLE> [LVDS current programming](#)

**D0** LVDS Data buffer current control

- 0 Default current, set by <LVDS\_CURR>
- 1 2x LVDS Current set by <LVDS\_CURR>

**D1** LVDS Clock buffer current control

- 0 Default current, set by <LVDS\_CURR>
- 1 2x LVDS Current set by <LVDS\_CURR>

**D3-D2** <LVDS CURRENT> [LVDS current programming](#)

- 00 3.5 mA
- 01 2.5 mA
- 10 4.5 mA
- 11 1.75 mA

**D9-D4** [LVDS internal termination](#)

**D9-D7** <DATA TERM> Internal termination for LVDS output data bits

- 000 No internal termination
- 001 300 Ω
- 010 185 Ω
- 011 115 Ω
- 100 150 Ω
- 101 100 Ω
- 110 80 Ω
- 111 65 Ω

**D6-D4** <CLKOUT TERM> Internal termination for LVDS output clock

- 000 No internal termination
- 001 300 Ω
- 010 185 Ω
- 011 115 Ω
- 100 150 Ω
- 101 100 Ω
- 110 80 Ω
- 111 65 Ω

**Table 12.**

A4–A0 (hex)	D10	D9	D8	D7	D6	D5	D4	D3	D2	D1	D0
0F	0	0	0	<DRIVE STRENGTH> CMOS output buffer drive strength control				0	0	0	0

**D7-D4** <DRIVE STRENGTH> [Output buffer drive strength controls](#)

- 0101 WEAKER than default drive
- 0000 DEFAULT drive strength
- 1111 STRONGER than default drive strength (recommended for load capacitances > 5 pF)
- 1010 MAXIMUM drive strength (recommended for load capacitances > 5 pF)
- Other Do not use combinations

## PIN CONFIGURATION (CMOS MODE)

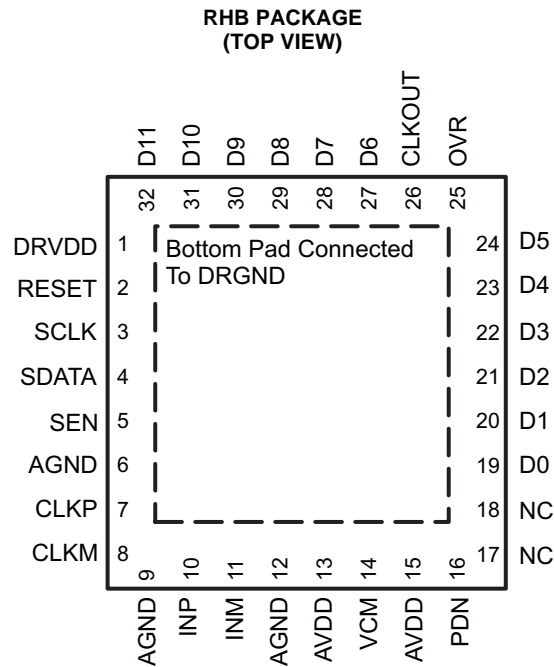

**Figure 7. CMOS Mode Pinout**

**Table 13. Pin Assignments – CMOS Mode**

PIN NAME	DESCRIPTION	PIN TYPE	PIN NUMBER	NUMBER OF PINS
AVDD	Analog power supply	I	13, 15	2
AGND	Analog ground	I	6, 9, 12	3
CLKP, CLKM	Differential clock input	I	7, 8	2
INP, INM	Differential analog input	I	10, 11	2
VCM	Internal reference mode – common-mode voltage output. External reference mode – reference input. The voltage forced on this pin sets the internal references.	I/O	14	1
RESET	Serial interface RESET input. When using the serial interface mode, the user MUST initialize internal registers through hardware RESET by applying a high-going pulse on this pin, or by using the software reset option. See the <i>SERIAL INTERFACE</i> section. In parallel interface mode, the user has to tie the RESET pin permanently HIGH. (SCLK, SDATA and SEN are used as parallel pin controls in this mode) The pin has an internal 100-kΩ pull-down resistor.	I	2	1
SCLK	This pin functions as serial interface clock input when RESET is low. When RESET is tied high, it controls the coarse gain and internal/external reference selection. Tie SCLK to <b>low</b> for internal reference and 0 dB gain and <b>high</b> for internal reference and 3.5 dB gain. See <a href="#">Table 1</a> . The pin has an internal 100-kΩ pull-down resistor.	I	3	1
SDATA	This pin functions as serial interface data input when RESET is <b>low</b> . It controls various power down modes along with PDN pin when RESET is tied <b>high</b> . See <a href="#">Table 3</a> for detailed information. The pin has an internal 100 kΩ pull-down resistor.	I	4	1
SEN	This pin functions as serial interface enable input when RESET is <b>low</b> . When RESET is high, it controls output interface type and data formats. See <a href="#">Table 2</a> for detailed information. The pin has an internal 100-kΩ pull-up resistor to DRVDD.	I	5	1
PDN	Global power down control pin	I	16	1

**Table 13. Pin Assignments – CMOS Mode (continued)**

PIN NAME	DESCRIPTION	PIN TYPE	PIN NUMBER	NUMBER OF PINS
CLKOUT	CMOS Output clock	O	26	1
D0	CMOS Output data D0	O	19	1
D1	CMOS Output data D1	O	20	1
D2	CMOS Output data D2	O	21	1
D3	CMOS Output data D3	O	22	1
D4	CMOS Output data D4	O	23	1
D5	CMOS Output data D5	O	24	1
D6	CMOS Output data D6	O	27	1
D7	CMOS Output data D7	O	28	1
D8	CMOS Output data D8	O	29	1
D9	CMOS Output data D9	O	30	1
D10	CMOS Output data D10	O	31	1
D11	CMOS Output data D11	O	32	1
OVR	Indicates over-voltage on analog inputs (for differential input greater than full-scale), CMOS level	O	25	1
DRVDD	Digital supply	I	1	1
DRGND	Digital ground. Connect the pad to the ground plane. See <a href="#">Board Design Considerations</a> in application information section.	I	PAD	1
NC	Do not connect		17,18	2

## PIN CONFIGURATION (LVDS MODE)

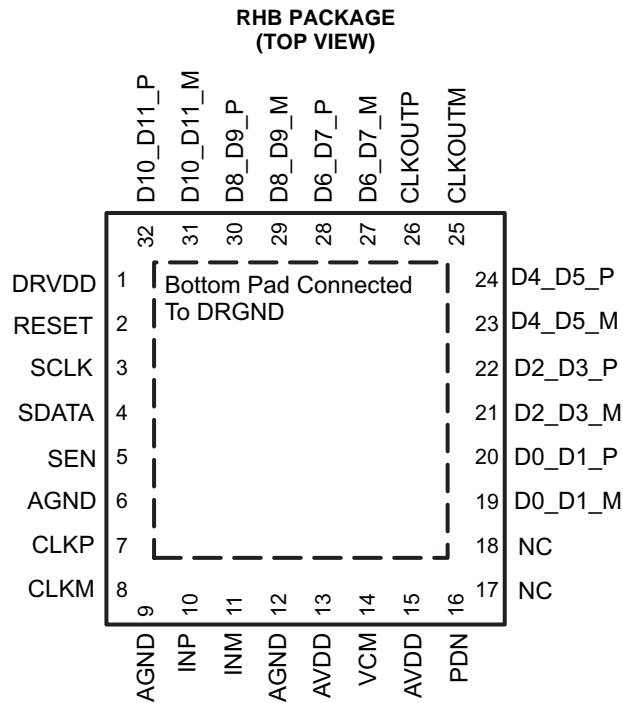

**Figure 8. LVDS Mode Pinout**

**Table 14. Pin Assignments – LVDS Mode**

PIN NAME	DESCRIPTION	PIN TYPE	PIN NUMBER	NUMBER OF PINS
AVDD	Analog power supply	I	13, 15	2
AGND	Analog ground	I	6, 9, 12	3
CLKP, CLKM	Differential clock input	I	7, 8	2
INP, INM	Differential analog input	I	10, 11	2
VCM	Internal reference mode – common-mode voltage output. External reference mode – reference input. The voltage forced on this pin sets the internal references.	I/O	14	1
RESET	Serial interface RESET input. When using the serial interface mode, the user <b>MUST</b> initialize internal registers through hardware RESET by applying a high-going pulse on this pin, or by using the software reset option. See the <i>SERIAL INTERFACE</i> section. In parallel interface mode, the user has to tie the RESET pin permanently HIGH. (SCLK, SDATA and SEN are used as parallel pin controls in this mode) The pin has an internal 100-kΩ pull-down resistor.	I	2	1
SCLK	This pin functions as serial interface clock input when RESET is low. When RESET is tied high, it controls the coarse gain and internal/external reference selection. Tie SCLK to <b>low</b> for internal reference and 0 dB gain and <b>high</b> for internal reference and 3.5 dB gain. See <a href="#">Table 1</a> . The pin has an internal 100-kΩ pull-down resistor.	I	3	1
SDATA	This pin functions as serial interface data input when RESET is <b>low</b> . It controls various power down modes along with PDN pin when RESET is tied <b>high</b> . See <a href="#">Table 3</a> for detailed information. The pin has an internal 100 kΩ pull-down resistor.	I	4	1
SEN	This pin functions as serial interface enable input when RESET is <b>low</b> . When RESET is high, it controls output interface type and data formats. See <a href="#">Table 2</a> for detailed information. The pin has an internal 100-kΩ pull-up resistor to DRVDD.	I	5	1
PDN	Global power down control pin	I	16	1

**Table 14. Pin Assignments – LVDS Mode (continued)**

PIN NAME	DESCRIPTION	PIN TYPE	PIN NUMBER	NUMBER OF PINS
CLKOUTP	Differential output clock, true	O	26	1
CLKOUTM	Differential output clock, complement	O	25	1
D0_D1_P	Differential output data D0 and D1 multiplexed, true	O	20	1
D0_D1_M	Differential output data D0 and D1 multiplexed, complement.	O	19	1
D2_D3_P	Differential output data D2 and D3 multiplexed, true	O	22	1
D2_D3_M	Differential output data D2 and D3 multiplexed, complement	O	21	1
D4_D5_P	Differential output data D4 and D5 multiplexed, true	O	24	1
D4_D5_M	Differential output data D4 and D5 multiplexed, complement	O	23	1
D6_D7_P	Differential output data D6 and D7 multiplexed, true	O	28	1
D6_D7_M	Differential output data D6 and D7 multiplexed, complement	O	27	1
D8_D9_P	Differential output data D8 and D9 multiplexed, true	O	30	1
D8_D9_M	Differential output data D8 and D9 multiplexed, complement	O	29	1
D10_D11_P	Differential output data D10 and D11 multiplexed, true	O	32	1
D10_D11_M	Differential output data D10 and D11 multiplexed, complement	O	31	1
DRVDD	Digital supply	I	1	1
DRGND	Digital ground. Connect the pad to the ground plane. See <a href="#">Board Design Considerations</a> in application information section.	I	PAD	1
NC	Do not connect		17,18	2



### TYPICAL CHARACTERISTICS - ADS6125 ( $F_s = 125$ MSPS)

All plots are at 25°C, AVDD = DRVDD = 3.3 V, maximum rated sampling frequency, sine wave input clock, 1.5 V<sub>PP</sub> differential clock amplitude, 50% clock duty cycle, -1 dBFS differential analog input, internal reference mode, 0 dB gain, CMOS output interface (unless otherwise noted)

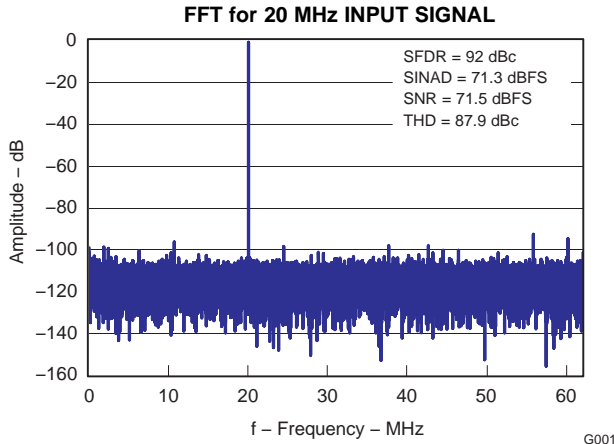

Figure 9.

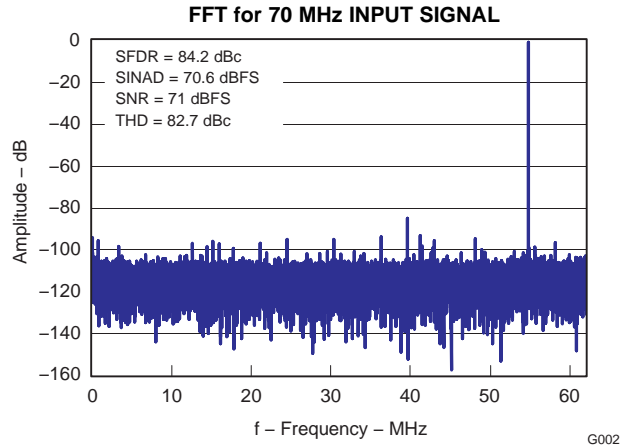

Figure 10.

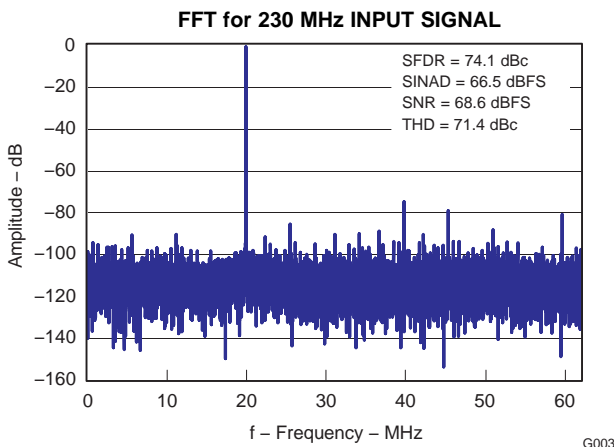

Figure 11.

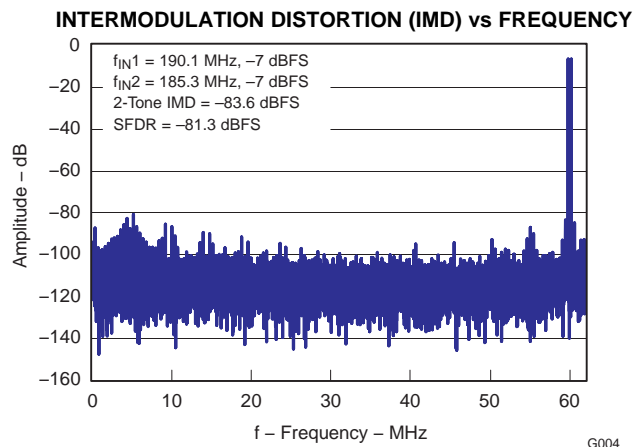

Figure 12.

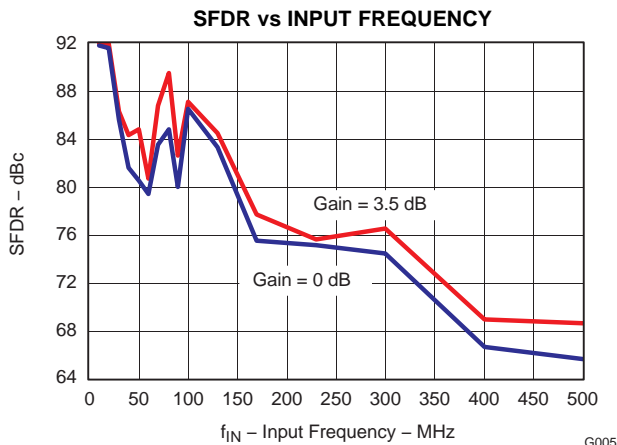

Figure 13.

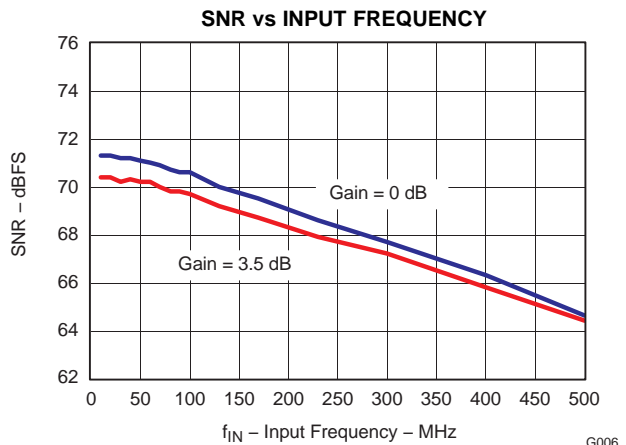

Figure 14.

**TYPICAL CHARACTERISTICS - ADS6125 ( $F_S = 125$  MSPS) (continued)**

All plots are at 25°C, AVDD = DRVDD = 3.3 V, maximum rated sampling frequency, sine wave input clock, 1.5 V<sub>PP</sub> differential clock amplitude, 50% clock duty cycle, -1 dBFS differential analog input, internal reference mode, 0 dB gain, CMOS output interface (unless otherwise noted)

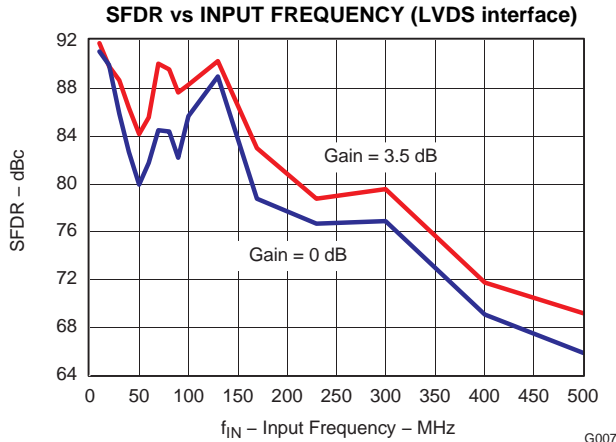

Figure 15.

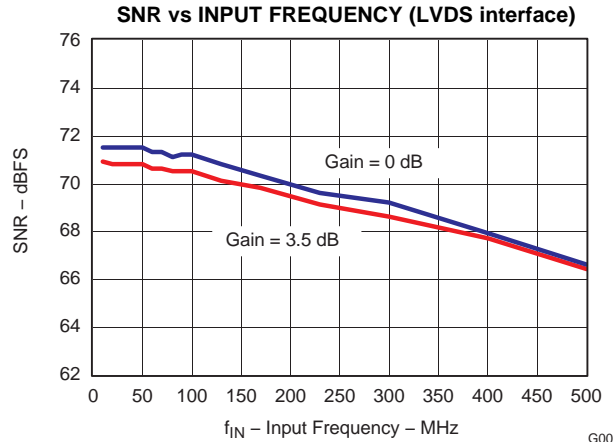

Figure 16.

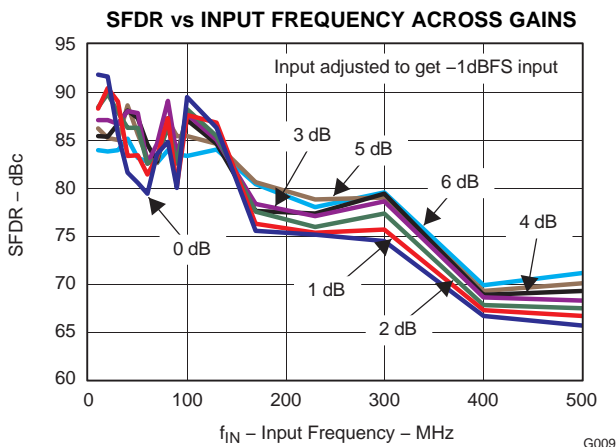

Figure 17.

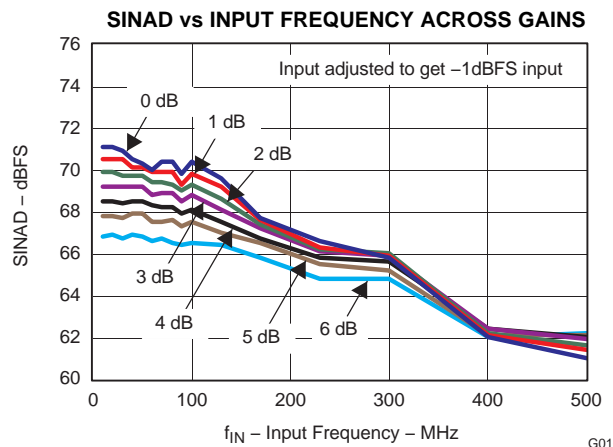

Figure 18.

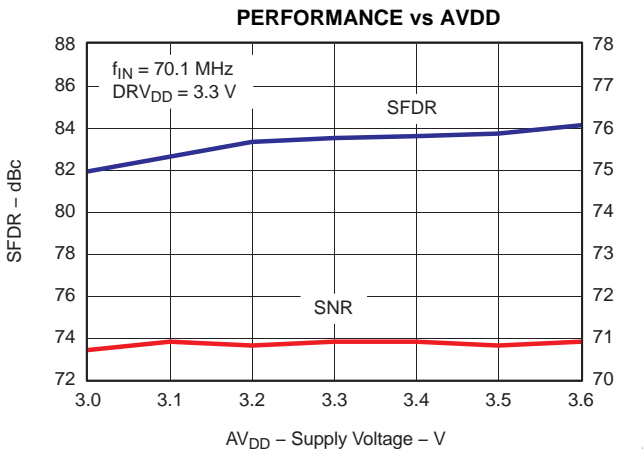

Figure 19.

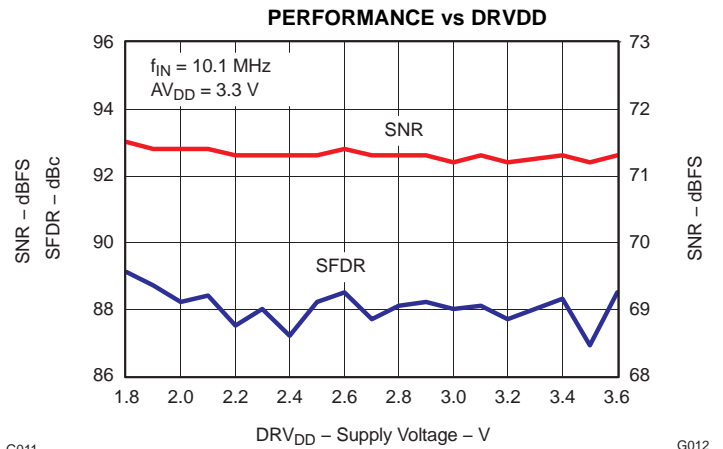

Figure 20.

### TYPICAL CHARACTERISTICS - ADS6125 ( $F_S = 125$ MSPS) (continued)

All plots are at 25°C, AVDD = DRVDD = 3.3 V, maximum rated sampling frequency, sine wave input clock, 1.5 V<sub>PP</sub> differential clock amplitude, 50% clock duty cycle, -1 dBFS differential analog input, internal reference mode, 0 dB gain, CMOS output interface (unless otherwise noted)

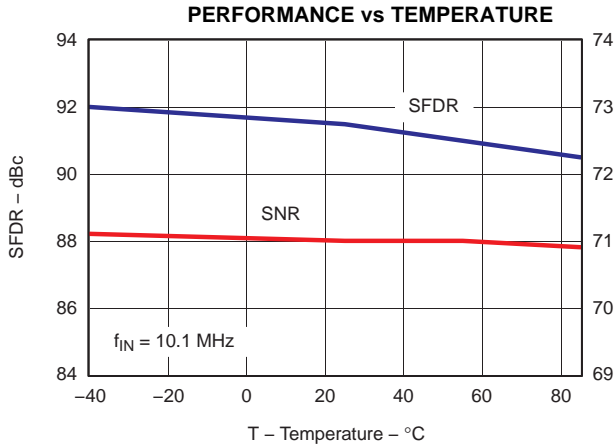

Figure 21.

G013

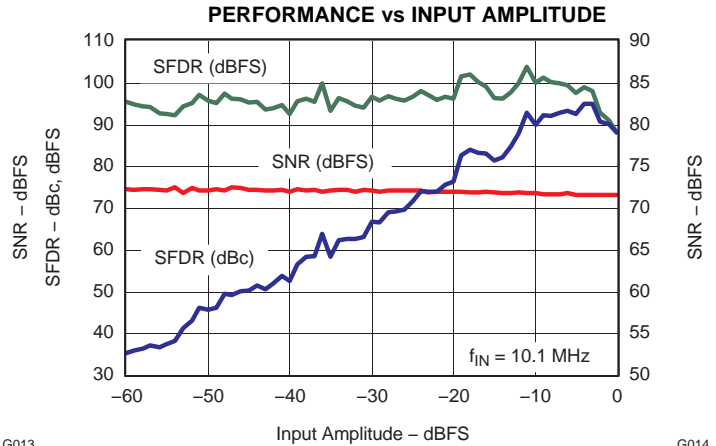

Figure 22.

G014

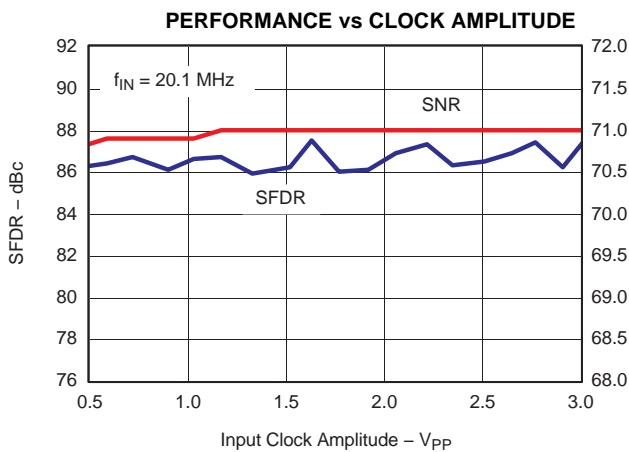

Figure 23.

G015

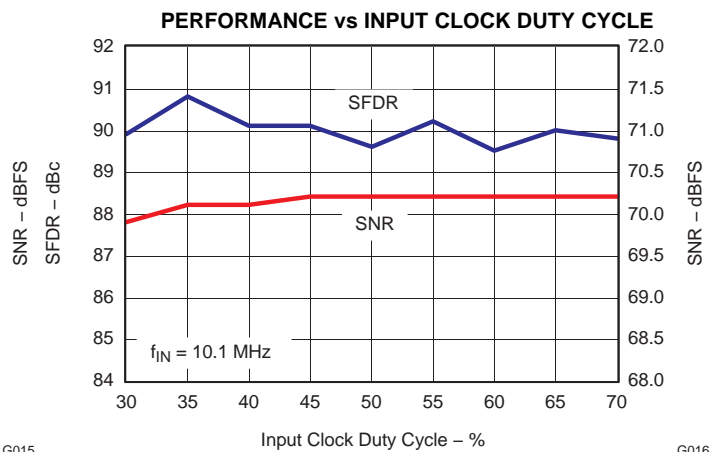

Figure 24.

G016

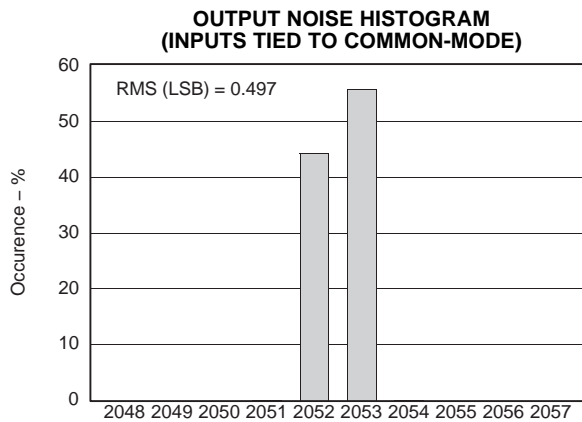

Figure 25.

G017

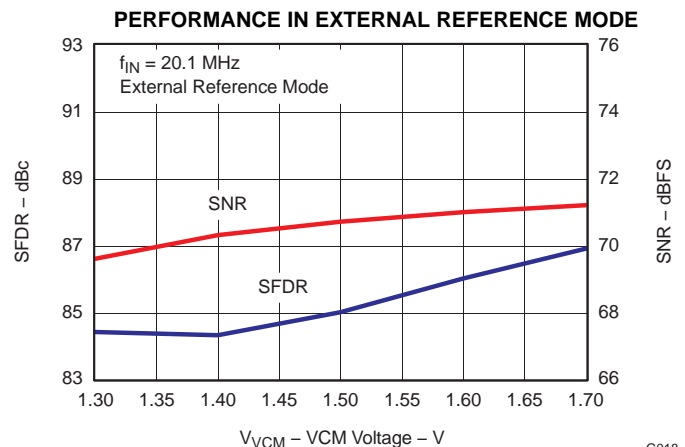

Figure 26.

G018

**TYPICAL CHARACTERISTICS - ADS6124 (F<sub>s</sub>= 105 MSPS)**

All plots are at 25°C, AVDD = DRVDD = 3.3 V, maximum rated sampling frequency, sine wave input clock, 1.5 V<sub>pp</sub> differential clock amplitude, 50% clock duty cycle, -1 dBFS differential analog input, internal reference mode, 0 dB gain, CMOS output interface (unless otherwise noted)

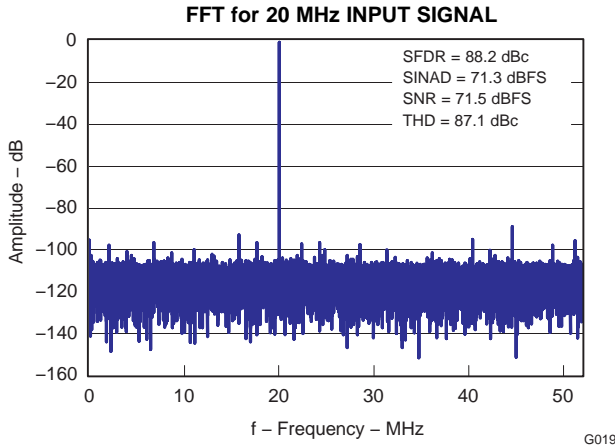

Figure 27.

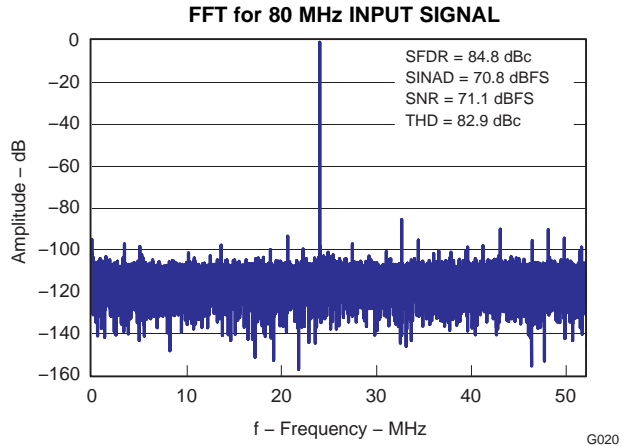

Figure 28.

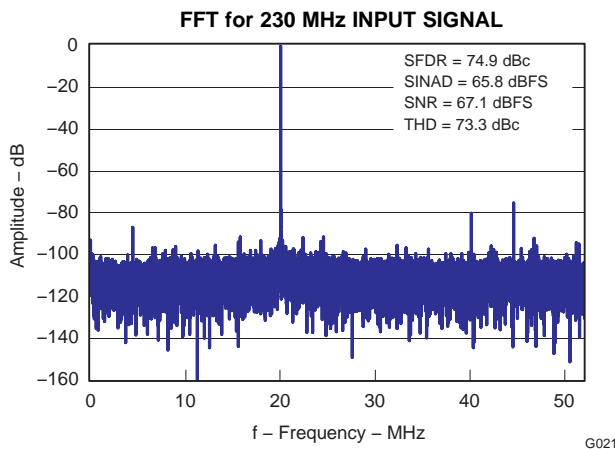

Figure 29.

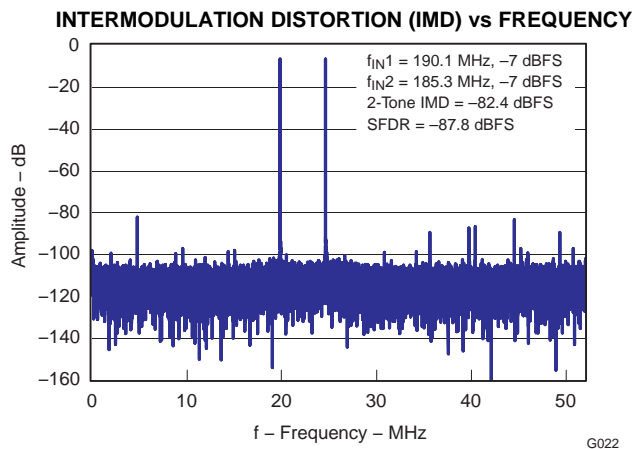

Figure 30.

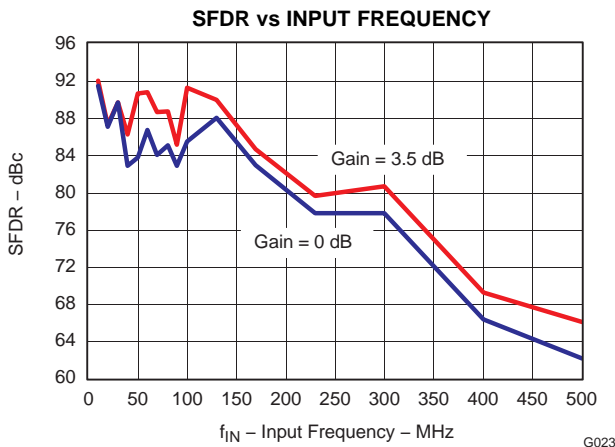

Figure 31.

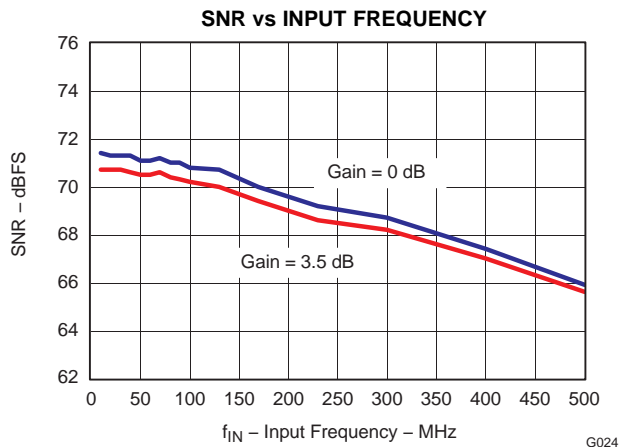

Figure 32.

**TYPICAL CHARACTERISTICS - ADS6124 ( $F_S= 105$  MSPS) (continued)**

All plots are at 25°C, AVDD = DRVDD = 3.3 V, maximum rated sampling frequency, sine wave input clock, 1.5 V<sub>PP</sub> differential clock amplitude, 50% clock duty cycle, -1 dBFS differential analog input, internal reference mode, 0 dB gain, CMOS output interface (unless otherwise noted)

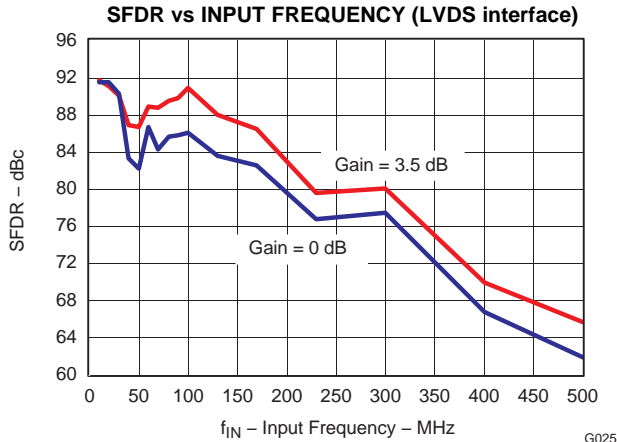

Figure 33.

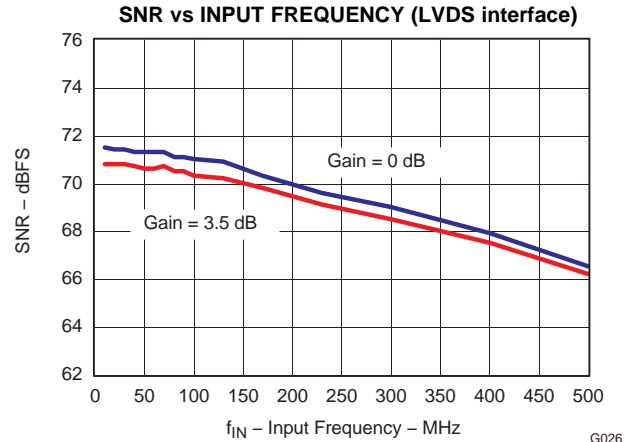

Figure 34.

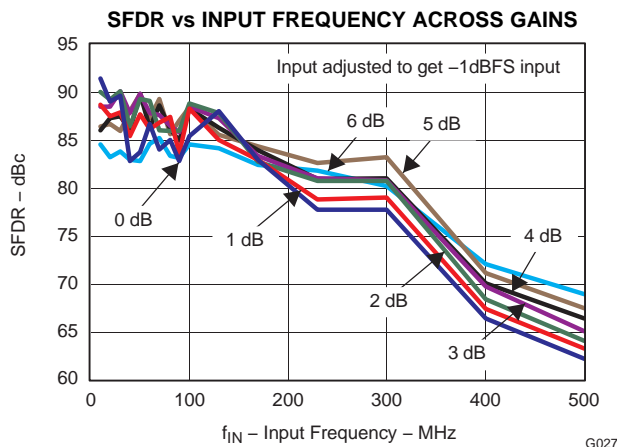

Figure 35.

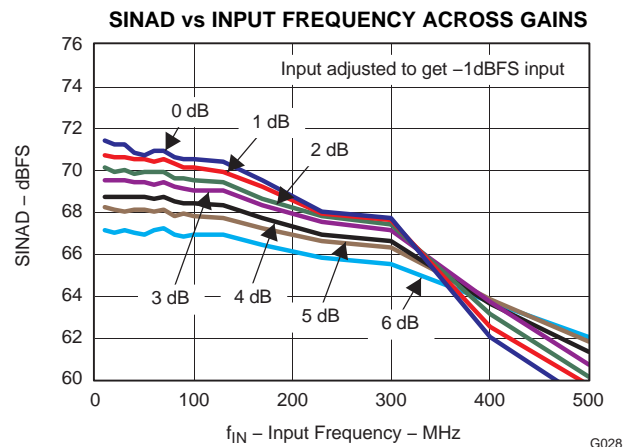

Figure 36.

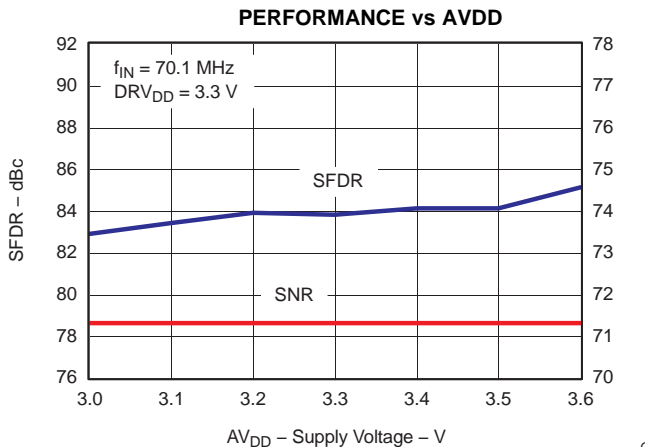

Figure 37.

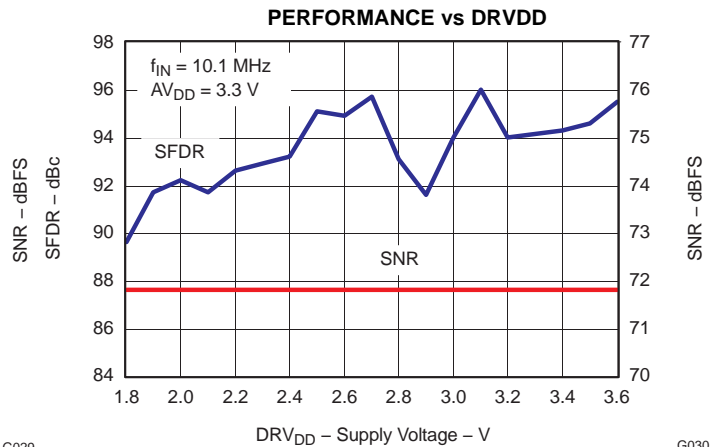

Figure 38.

**TYPICAL CHARACTERISTICS - ADS6124 (F<sub>s</sub>= 105 MSPS) (continued)**

All plots are at 25°C, AVDD = DRVDD = 3.3 V, maximum rated sampling frequency, sine wave input clock, 1.5 V<sub>PP</sub> differential clock amplitude, 50% clock duty cycle, -1 dBFS differential analog input, internal reference mode, 0 dB gain, CMOS output interface (unless otherwise noted)

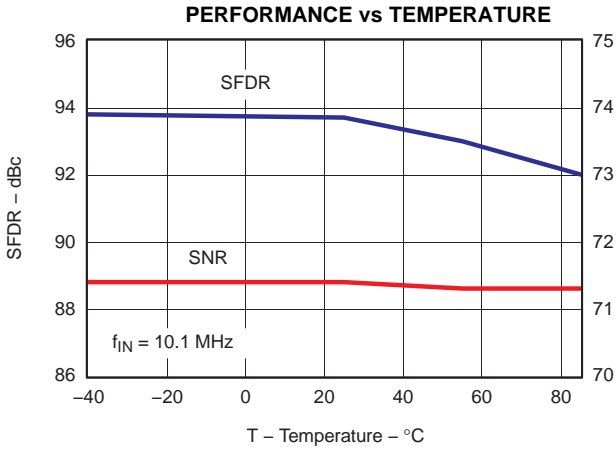

Figure 39.

G031

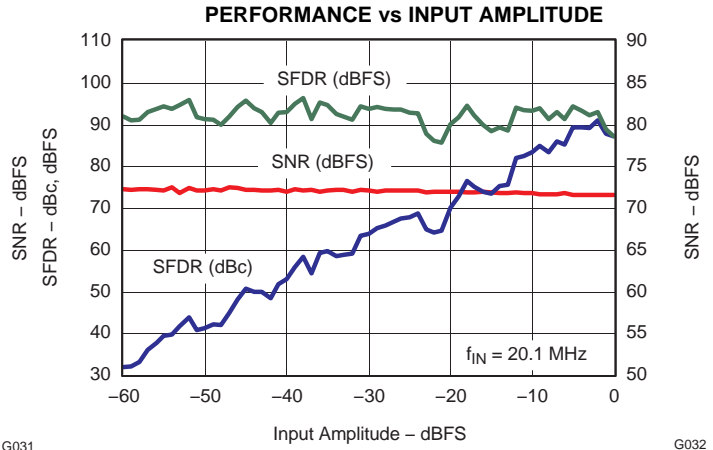

Figure 40.

G032

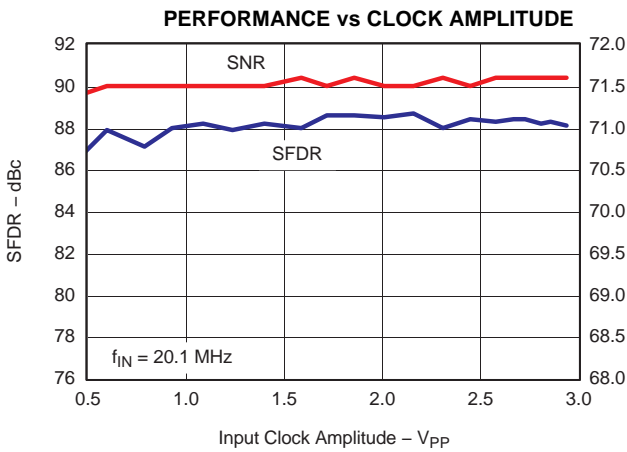

Figure 41.

G033

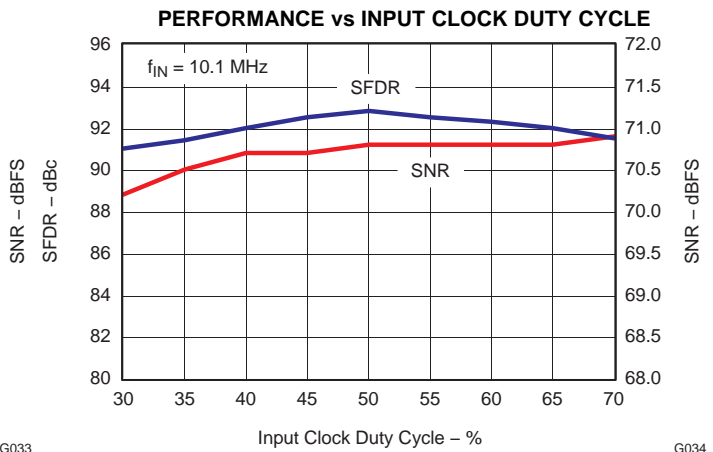

Figure 42.

G034

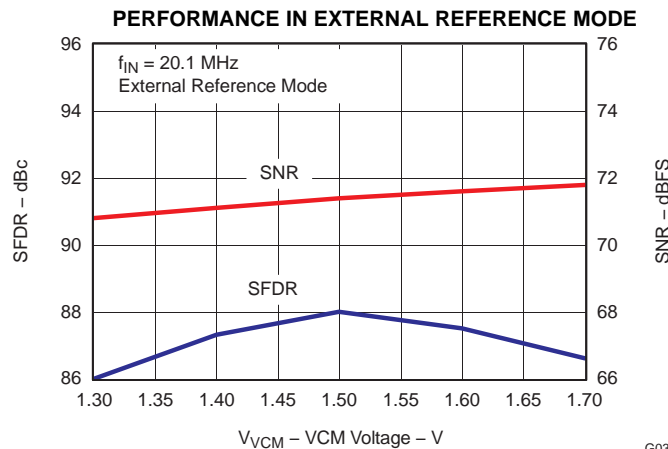

Figure 43.

G036

### TYPICAL CHARACTERISTICS - ADS6123 ( $F_S = 80$ MSPS)

All plots are at 25°C, AVDD = DRVDD = 3.3 V, maximum rated sampling frequency, sine wave input clock, 1.5 V<sub>PP</sub> differential clock amplitude, 50% clock duty cycle, -1 dBFS differential analog input, internal reference mode, 0 dB gain, CMOS output interface (unless otherwise noted)

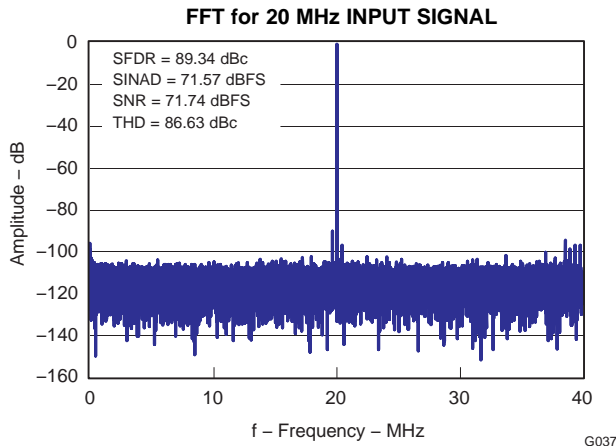

Figure 44.

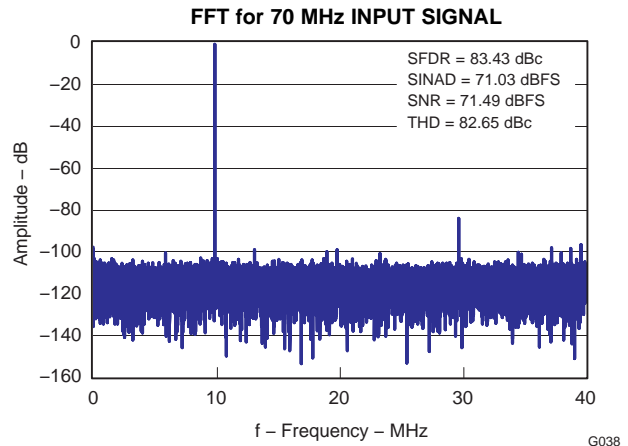

Figure 45.

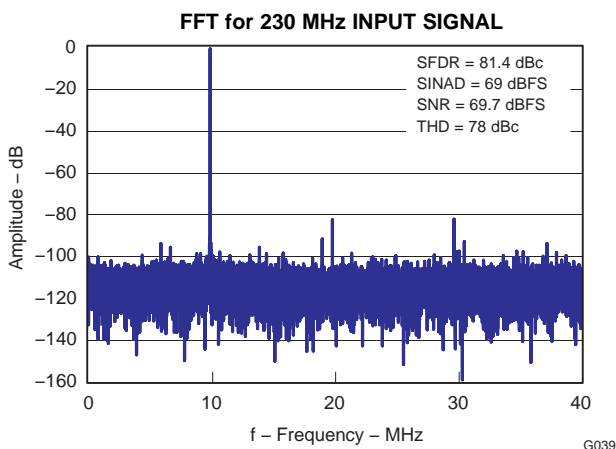

Figure 46.

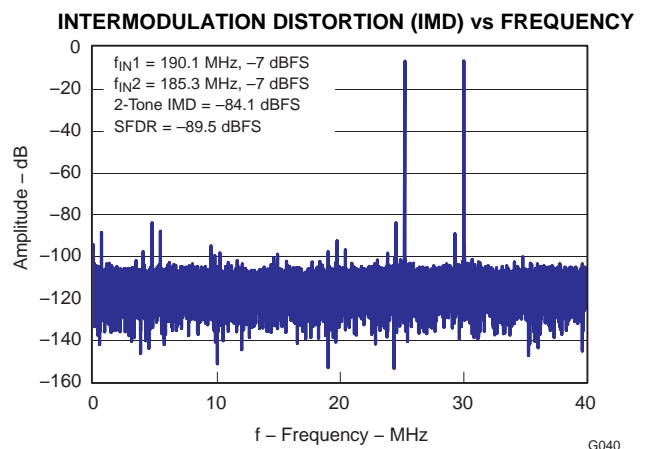

Figure 47.

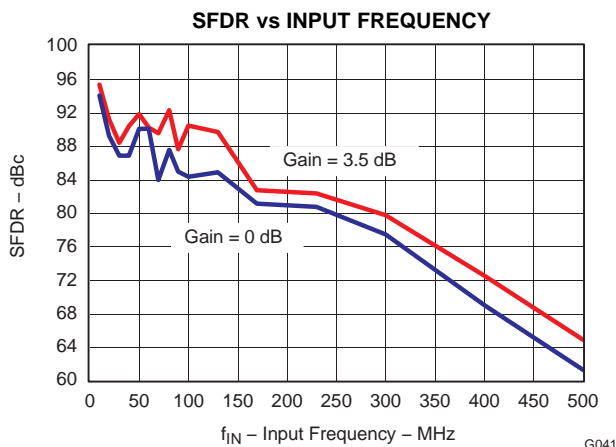

Figure 48.

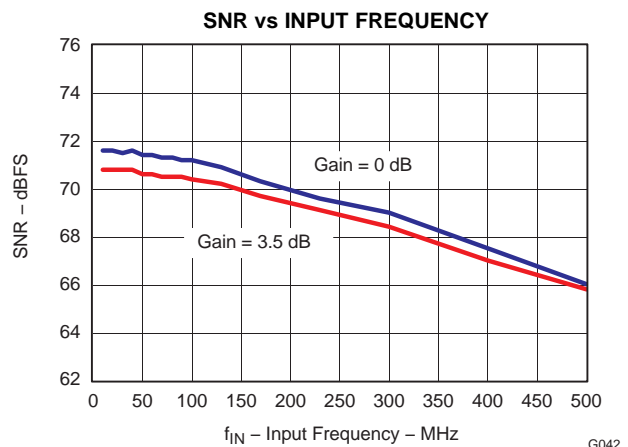

Figure 49.

**TYPICAL CHARACTERISTICS - ADS6123 ( $F_s=80$  MSPS) (continued)**

All plots are at 25°C, AVDD = DRVDD = 3.3 V, maximum rated sampling frequency, sine wave input clock, 1.5 V<sub>PP</sub> differential clock amplitude, 50% clock duty cycle, -1 dBFS differential analog input, internal reference mode, 0 dB gain, CMOS output interface (unless otherwise noted)

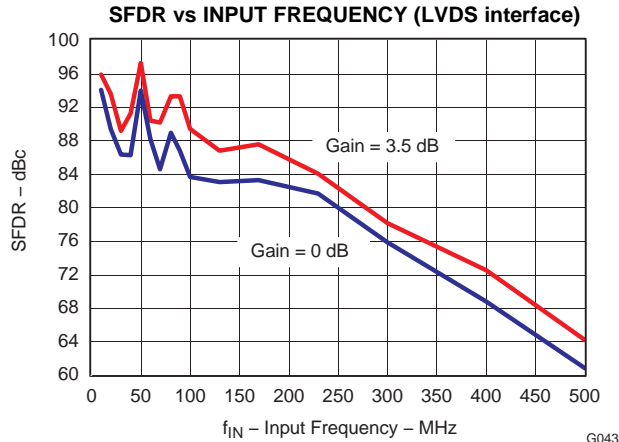

Figure 50.

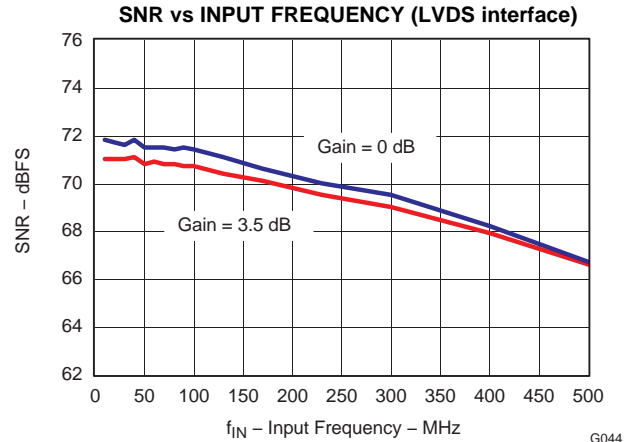

Figure 51.

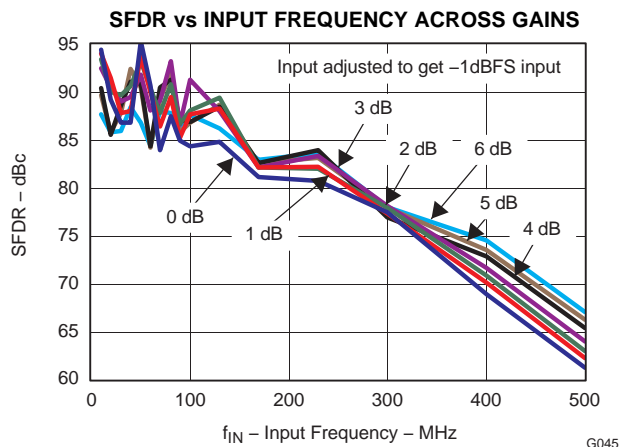

Figure 52.

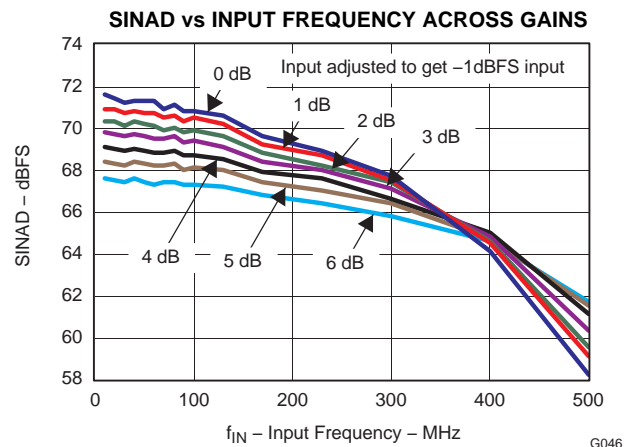

Figure 53.

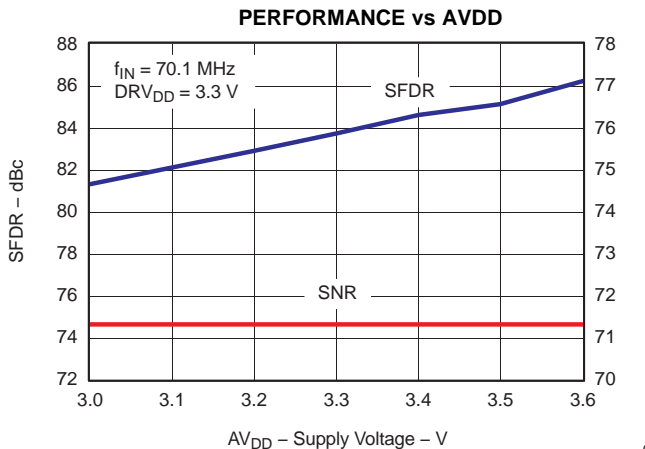

Figure 54.

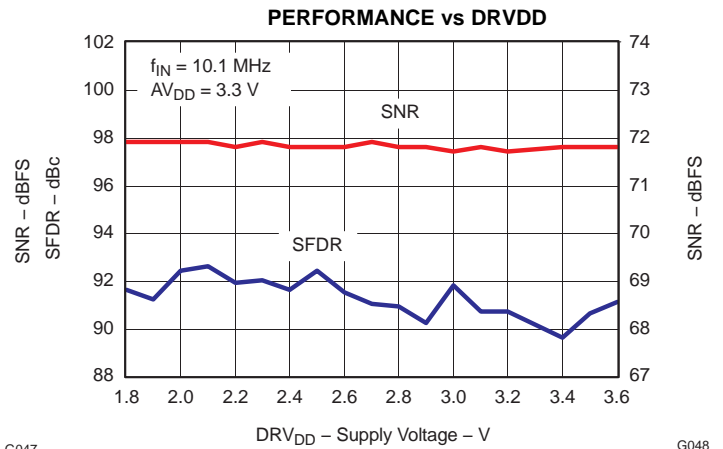

Figure 55.



**TYPICAL CHARACTERISTICS - ADS6123 ( $F_s=80$  MSPS) (continued)**

All plots are at 25°C, AVDD = DRVDD = 3.3 V, maximum rated sampling frequency, sine wave input clock, 1.5 V<sub>PP</sub> differential clock amplitude, 50% clock duty cycle, -1 dBFS differential analog input, internal reference mode, 0 dB gain, CMOS output interface (unless otherwise noted)

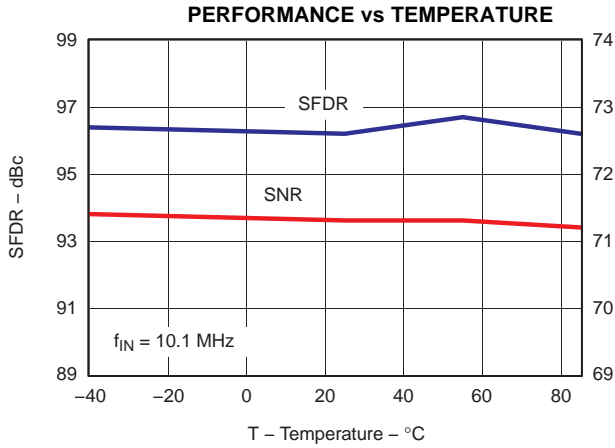

Figure 56.

G049

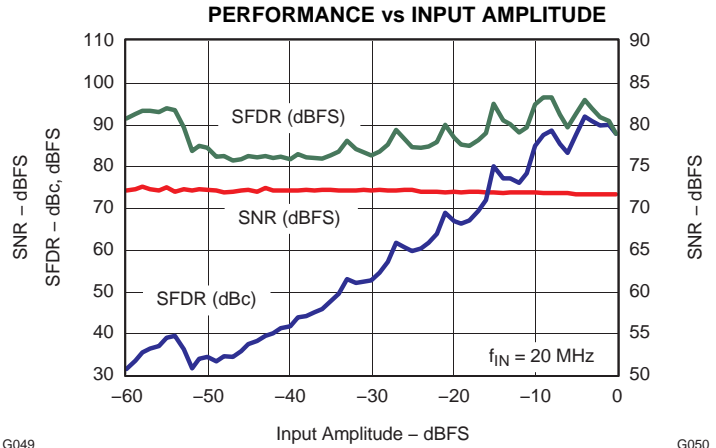

Figure 57.

G050

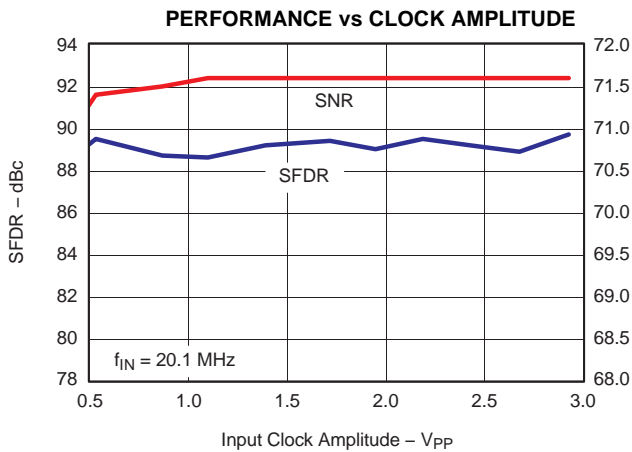

Figure 58.

G051

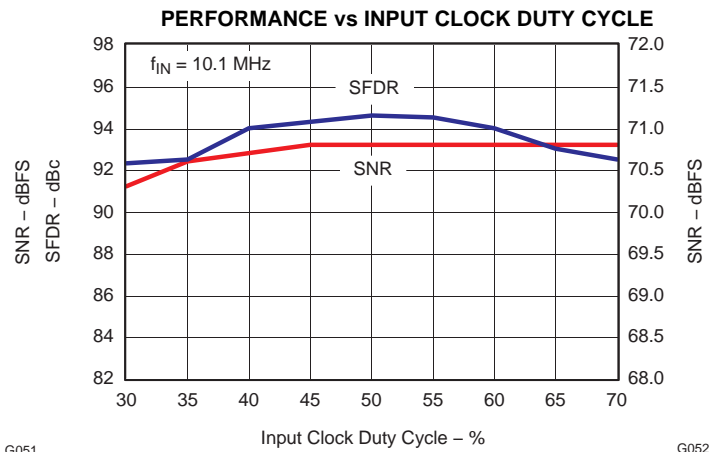

Figure 59.

G052

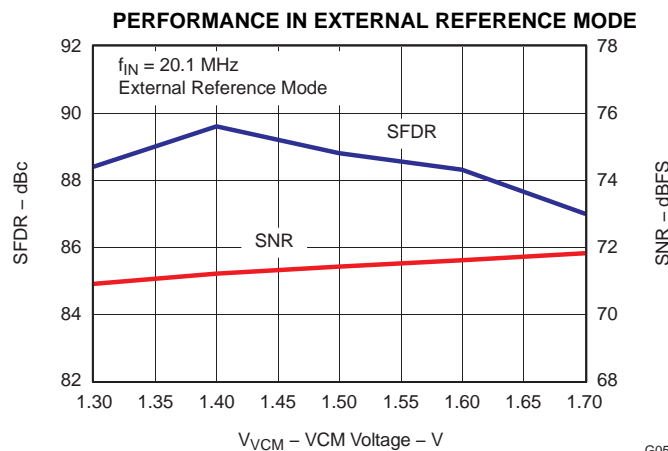

Figure 60.

G054

**TYPICAL CHARACTERISTICS - ADS6122 ( $F_S = 65$  MSPS)**

All plots are at 25°C, AVDD = DRVDD = 3.3 V, maximum rated sampling frequency, sine wave input clock, 1.5 V<sub>PP</sub> differential clock amplitude, 50% clock duty cycle, -1 dBFS differential analog input, internal reference mode, 0 dB gain, CMOS output interface (unless otherwise noted)

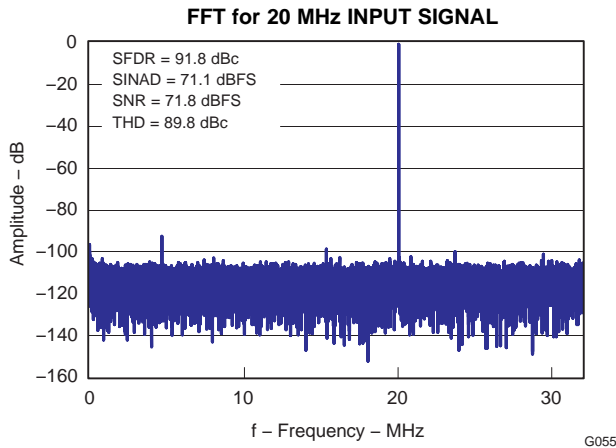

Figure 61.

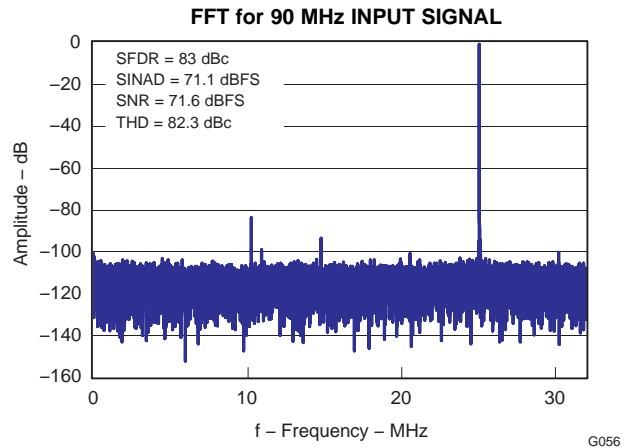

Figure 62.

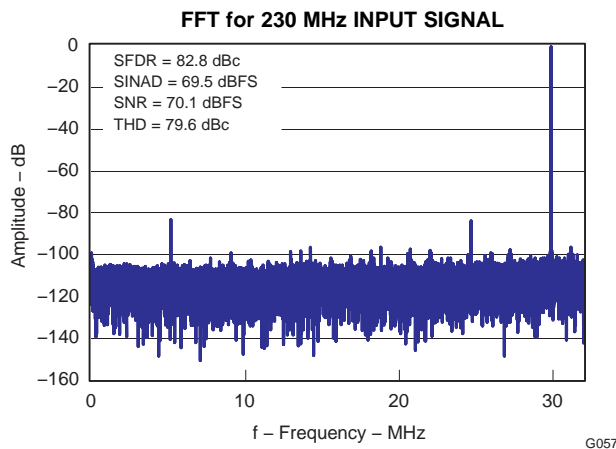

Figure 63.

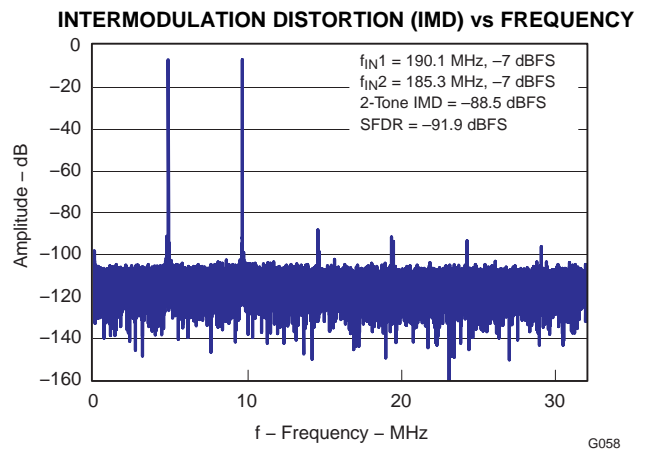

Figure 64.

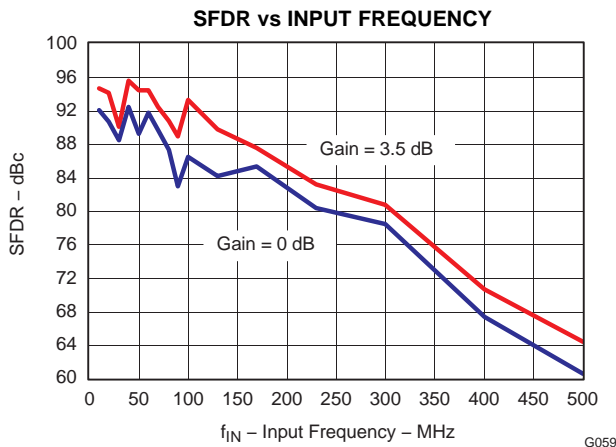

Figure 65.

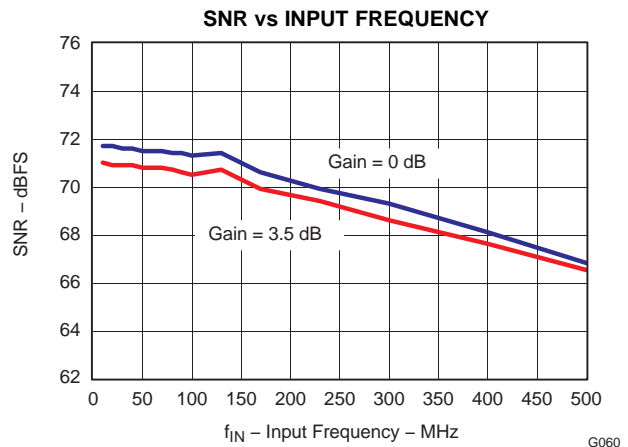

Figure 66.

**TYPICAL CHARACTERISTICS - ADS6122 ( $F_s=65$  MSPS) (continued)**

All plots are at 25°C, AVDD = DRVDD = 3.3 V, maximum rated sampling frequency, sine wave input clock, 1.5 V<sub>PP</sub> differential clock amplitude, 50% clock duty cycle, -1 dBFS differential analog input, internal reference mode, 0 dB gain, CMOS output interface (unless otherwise noted)

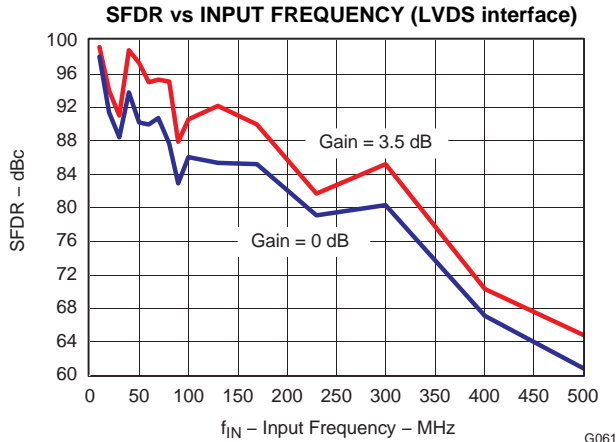

Figure 67.

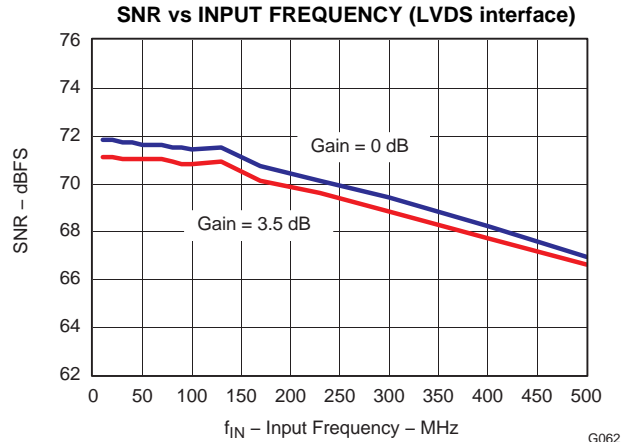

Figure 68.

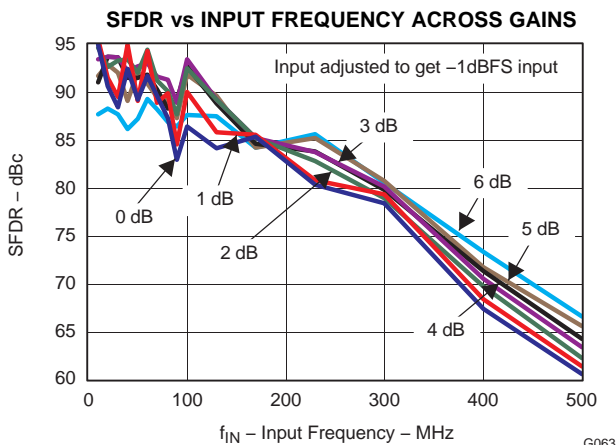

Figure 69.

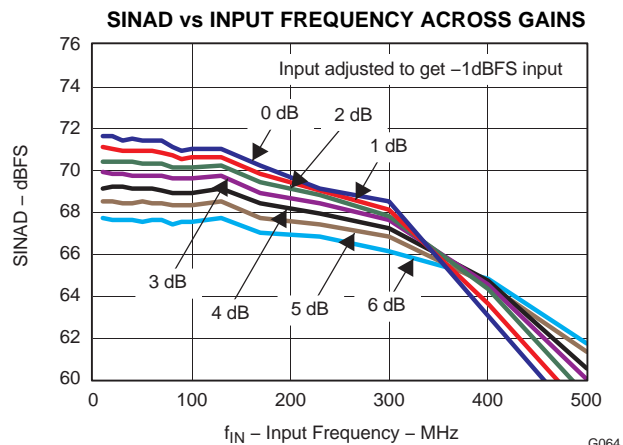

Figure 70.

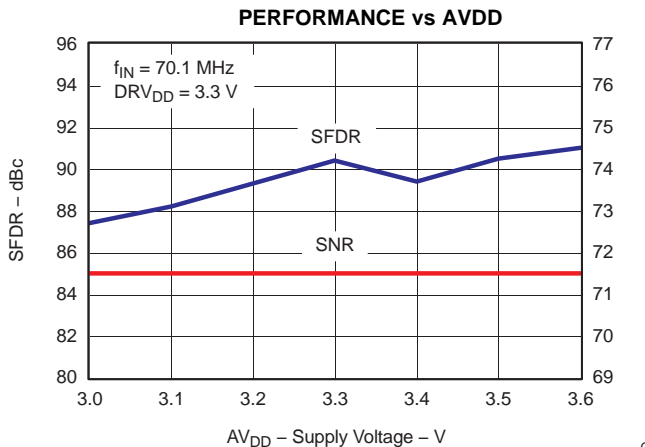

Figure 71.

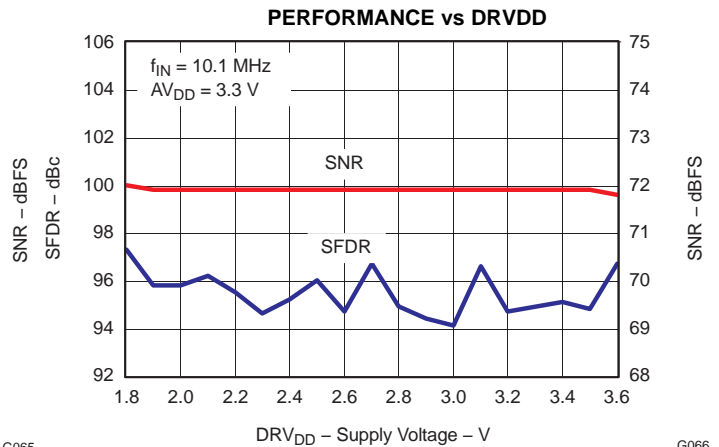

Figure 72.

**TYPICAL CHARACTERISTICS - ADS6122 ( $F_s=65$  MSPS) (continued)**

All plots are at 25°C, AVDD = DRVDD = 3.3 V, maximum rated sampling frequency, sine wave input clock, 1.5 V<sub>PP</sub> differential clock amplitude, 50% clock duty cycle, -1 dBFS differential analog input, internal reference mode, 0 dB gain, CMOS output interface (unless otherwise noted)

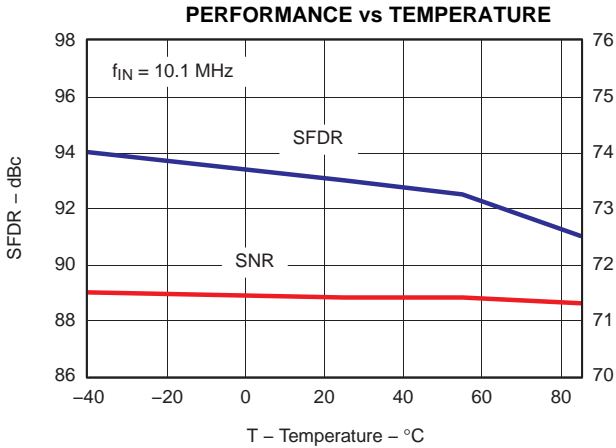

Figure 73.

G067

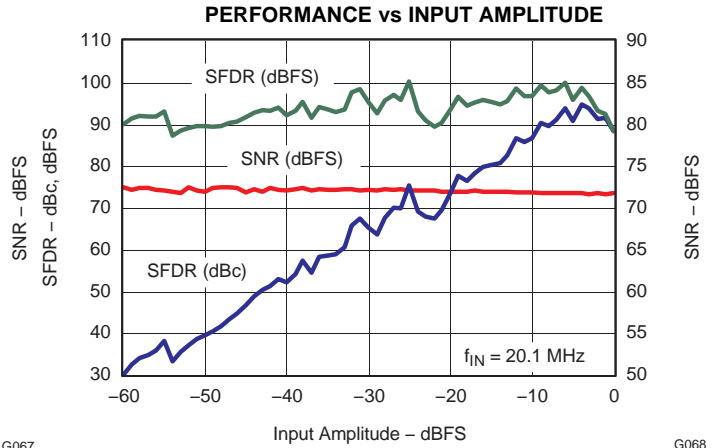

Figure 74.

G068

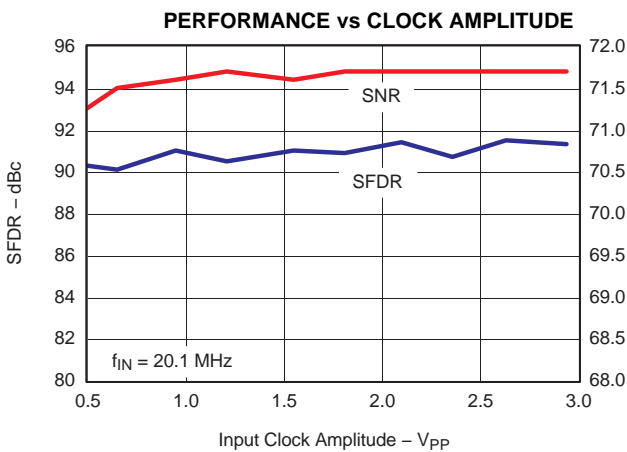

Figure 75.

G069

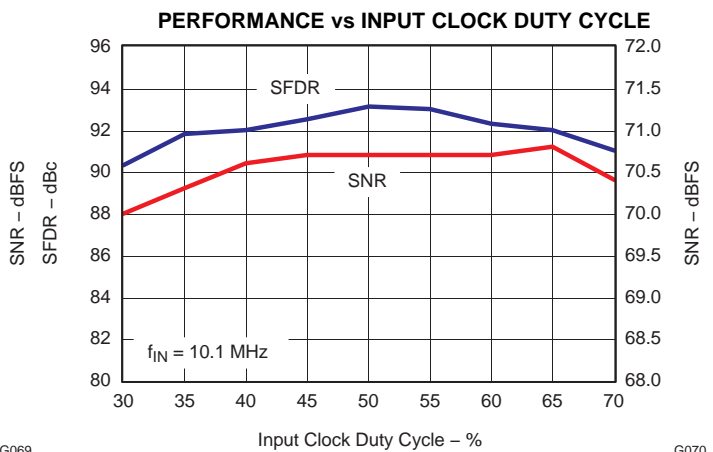

Figure 76.

G070

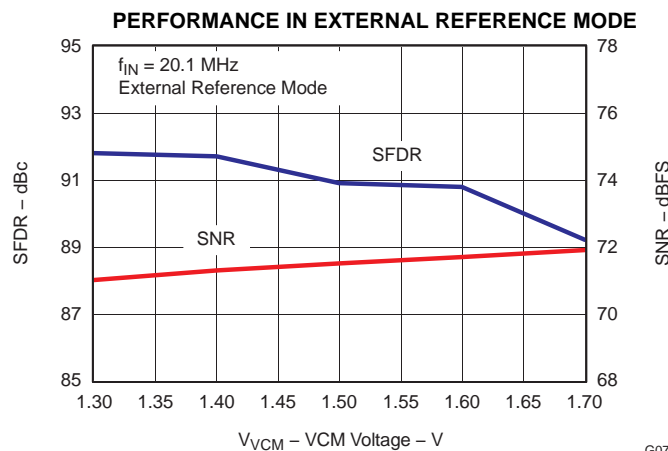

Figure 77.

G072

### TYPICAL CHARACTERISTICS - LOW SAMPLING FREQUENCIES

All plots are at 25°C, AVDD = DRVDD = 3.3 V, sine wave input clock, 1.5 V<sub>pp</sub> differential clock amplitude, 50% clock duty cycle, -1 dBFS differential analog input, internal reference mode, 0 dB gain, CMOS output interface (unless otherwise noted)

#### F<sub>S</sub> = 40 MSPS

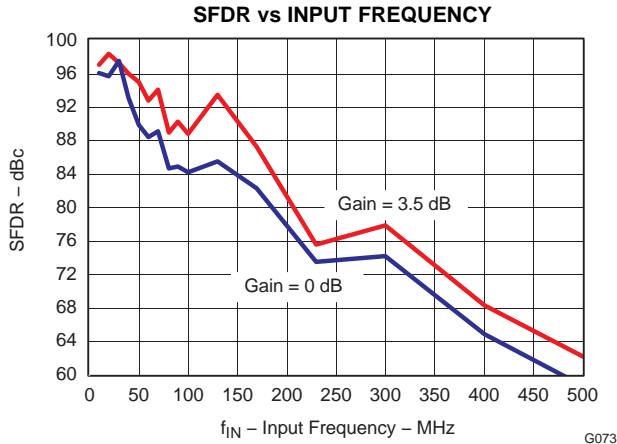

Figure 78.

G073

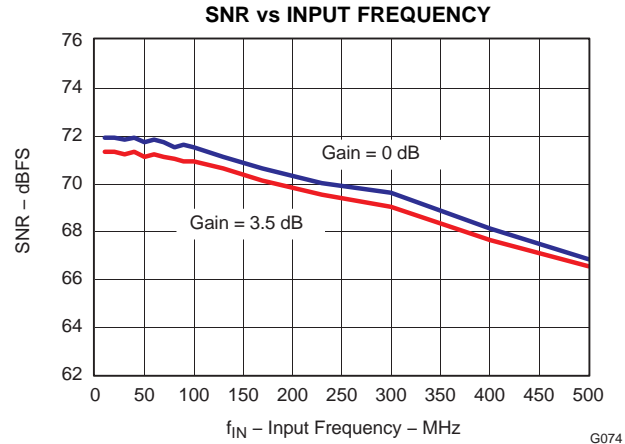

Figure 79.

G074

#### F<sub>S</sub> = 25 MSPS

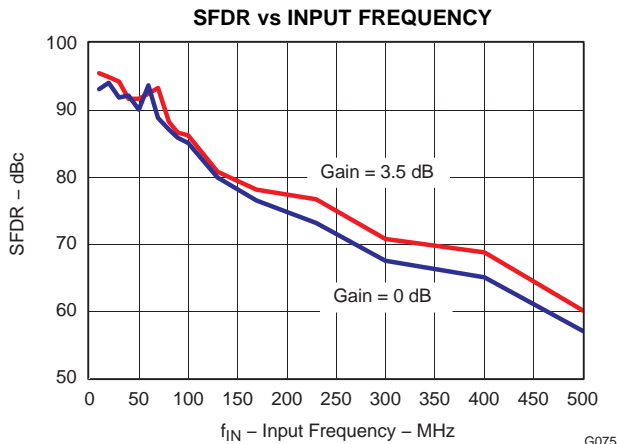

Figure 80.

G075

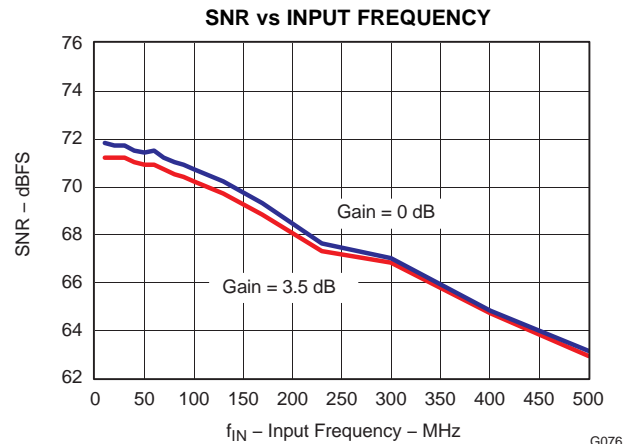

Figure 81.

G076

### COMMON PLOTS

All plots are at 25°C, AVDD = DRVDD = 3.3 V, sine wave input clock, 1.5 V<sub>pp</sub> differential clock amplitude, 50% clock duty cycle, -1 dBFS differential analog input, internal reference mode, 0 dB gain, CMOS output interface (unless otherwise noted)

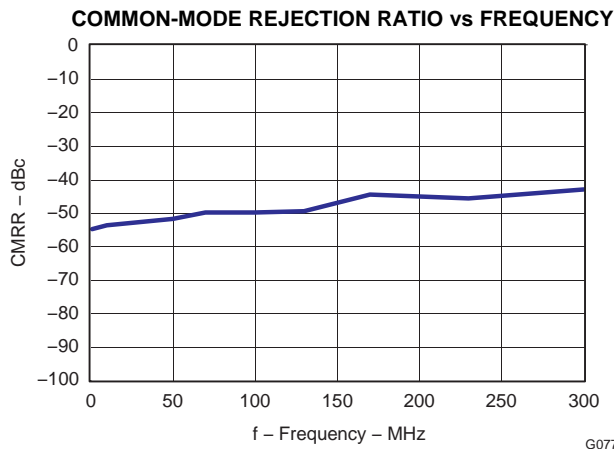

Figure 82.

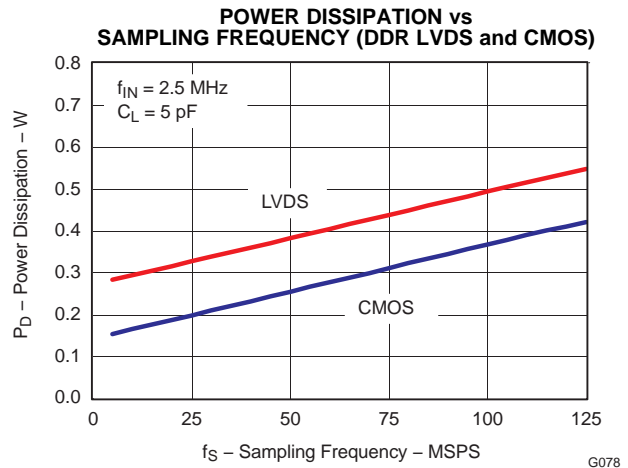

Figure 83.

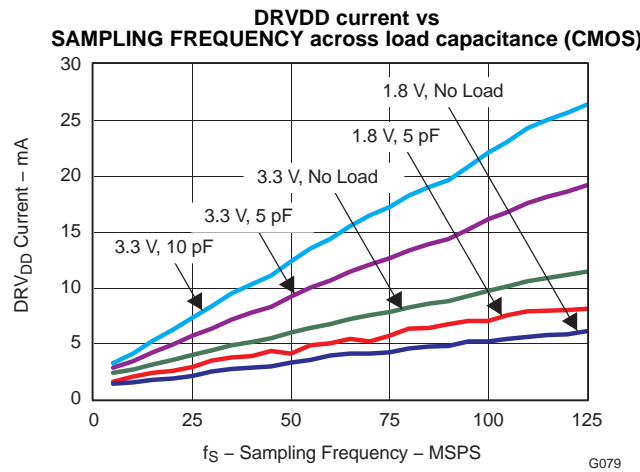
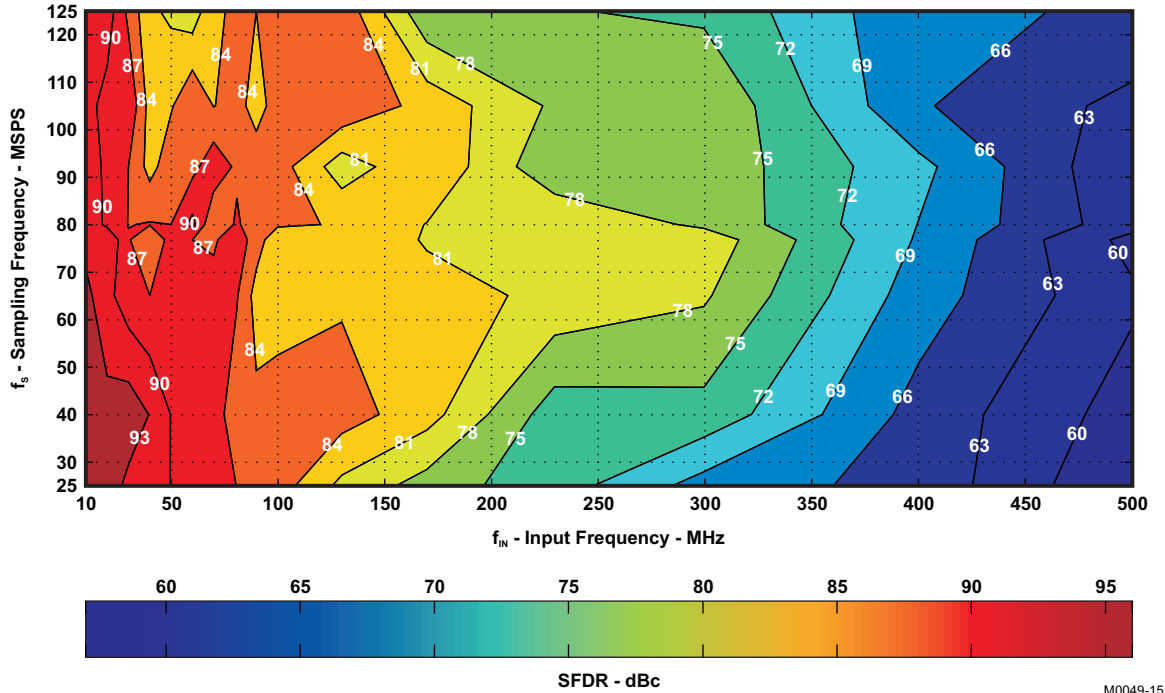
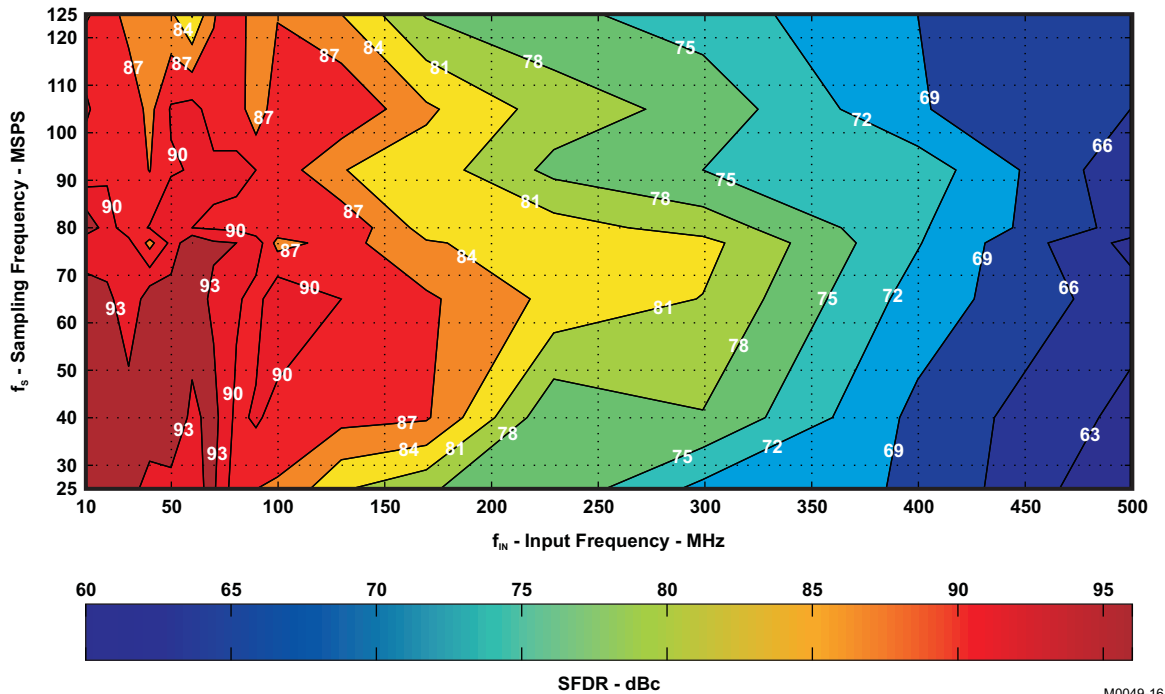

Figure 84.

**Contour Plots Across Input and Sampling Frequencies**

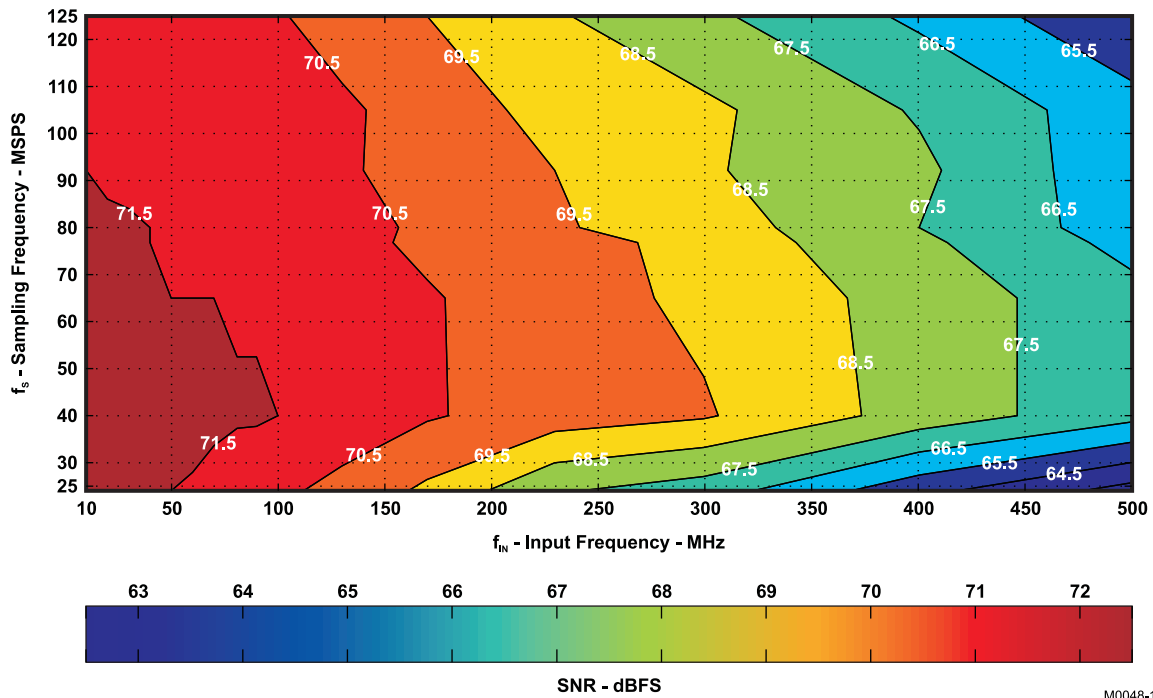

**Figure 85. SFDR Contour (No gain,  $F_S = 2 V_{PP}$ )**



**Figure 86. SFDR Contour (with 3.5 dB Coarse gain,  $F_S = 1.34 V_{PP}$ )**

Contour Plots Across Input and Sampling Frequencies (continued)



M0048-17

Figure 87. SNR Contour (No gain,  $F_S = 2 V_{PP}$ )

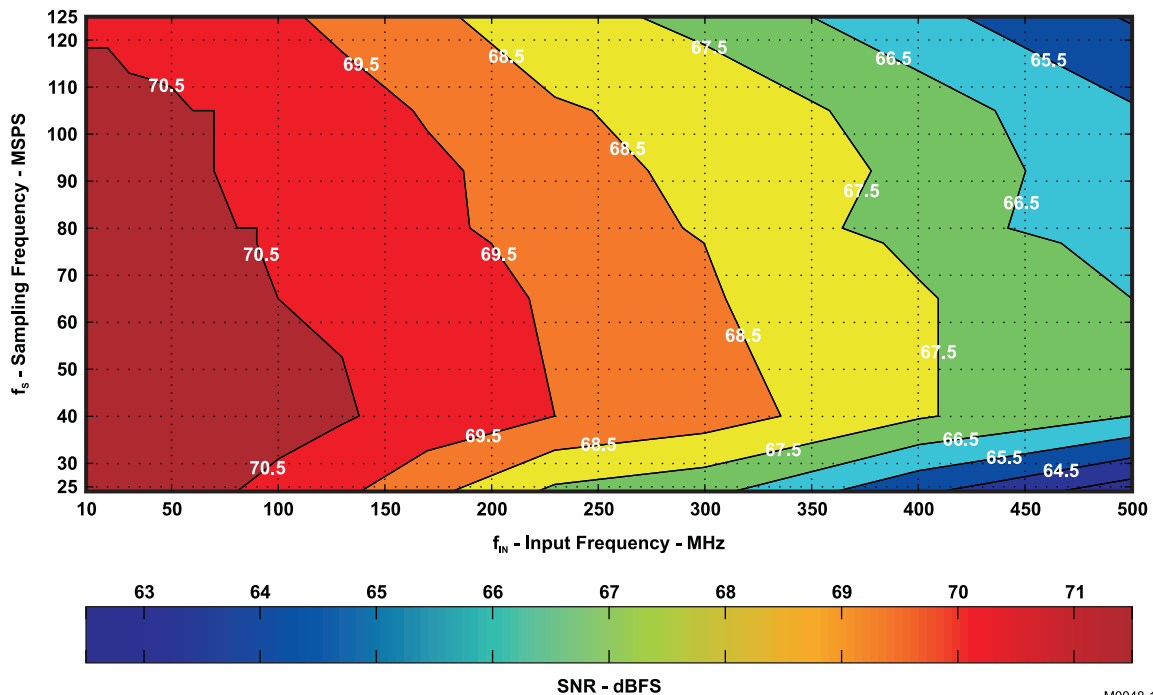

M0048-18

Figure 88. SNR Contour (with 3.5 dB Coarse gain,  $F_S = 1.34 V_{PP}$ )



## APPLICATION INFORMATION

### THEORY OF OPERATION

ADS612X is a family of low power 12-bit pipeline ADC in a CMOS process up to 125 MSPS sampling frequency. It is based on switched capacitor technology and runs off a single 3.3-V supply. The conversion process is initiated by a rising edge of the external input clock. Once the signal is captured by the input sample and hold, the input sample is sequentially converted by a series of lower resolution stages, with the outputs combined in a digital correction logic block. At every clock edge, the sample propagates through the pipeline resulting in a data latency of 9 clock cycles. The output is available as 12-bit data, in DDR LVDS or CMOS and coded in either straight offset binary or binary 2s complement format.

### ANALOG INPUT

The analog input consists of a switched-capacitor based differential sample and hold architecture, shown in Figure 89.

This differential topology results in good ac-performance even for high input frequencies at high sampling rates. The INP and INM pins have to be externally biased around a common-mode voltage of 1.5 V available on VCM pin. For a full-scale differential input, each input pin INP, INM has to swing symmetrically between  $V_{CM} + 0.5\text{ V}$  and  $V_{CM} - 0.5\text{ V}$ , resulting in a  $2\text{-}V_{PP}$  differential input swing. The maximum swing is determined by the internal reference voltages REFP (2.5 V nominal) and REFM (0.5 V, nominal).

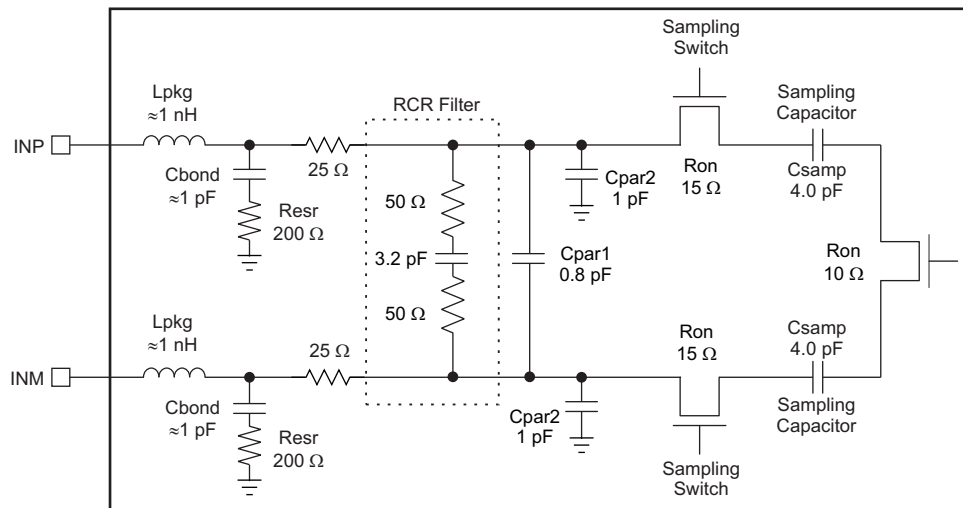

**Figure 89. Input Stage**

The input sampling circuit has a high 3-dB bandwidth that extends up to 450 MHz (measured from the input pins to the voltage across the sampling capacitors).

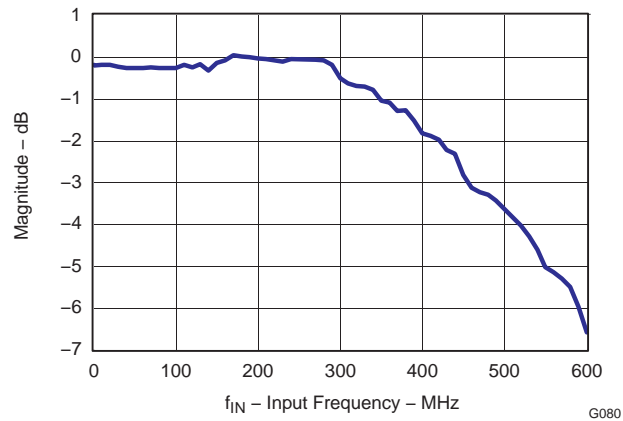

Figure 90. ADC Analog Input Bandwidth

### Drive Circuit Requirements

For optimum performance, the analog inputs must be driven differentially. This improves the common-mode noise immunity and even order harmonic rejection.

A 5-Ω resistor in series with each input pin is recommended to damp out ringing caused by the package parasitics. It is also necessary to present low impedance (< 50 Ω) for the common mode switching currents. For example, this is achieved by using two resistors from each input terminated to the common mode voltage (VCM).

In addition to the above, the drive circuit may have to be designed to provide a low insertion loss over the desired frequency range and matched impedance to the source. While doing this, the ADC input impedance must be considered. Over a wide frequency range, the input impedance can be approximated by a parallel combination of Rin and Cin ( $Z_{in} = R_{in} || C_{in}$ ).

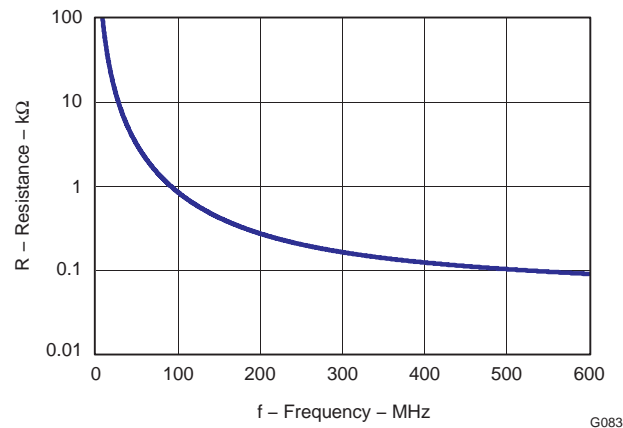

Figure 91. ADC Input Resistance, Rin

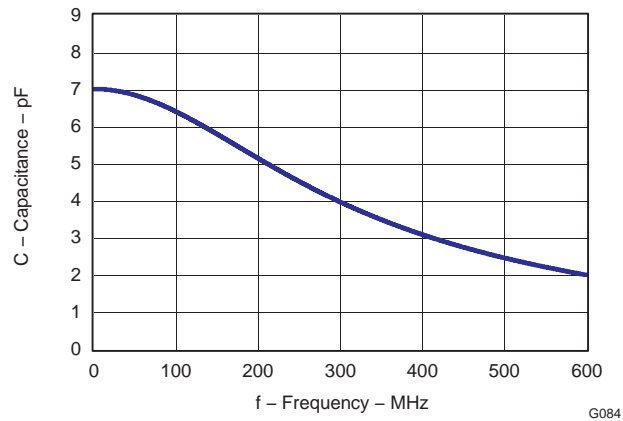

Figure 92. ADC Input Capacitance, Cin

### Using RF-Transformer Based Drive Circuits

Figure 93 shows a configuration using a single 1:1 turns ratio transformer (for example, Coilcraft WBC1-1) that can be used for low input frequencies (about 100 MHz).

The single-ended signal is fed to the primary winding of the RF transformer. The transformer is terminated on the secondary side. Putting the termination on the secondary side helps to shield the kickbacks caused by the sampling circuit from the RF transformer's leakage inductances. The termination is accomplished by two resistors connected in series, with the center point connected to the 1.5 V common mode (VCM pin). The value of the termination resistors (connected to common mode) has to be low (< 100 Ω) to provide a low-impedance path for the ADC common-mode switching current.

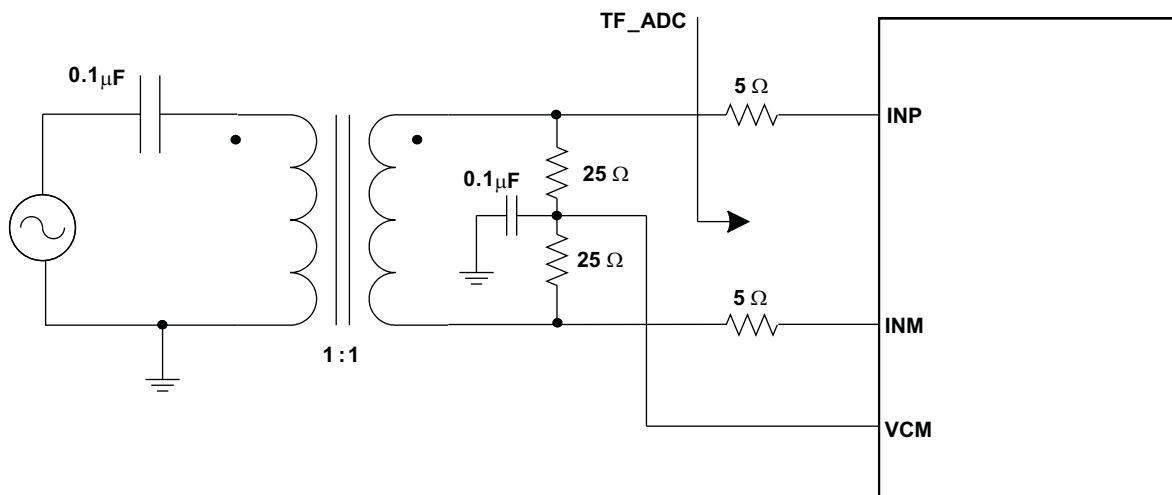

Figure 93. Single Transformer Drive Circuit

At high input frequencies, the mismatch in the transformer parasitic capacitance (between the windings) results in degraded even-order harmonic performance. Connecting two identical RF transformers back-to-back helps minimize this mismatch, and good performance is obtained for high frequency input signals. Figure 94 shows an example using two transformers (Coilcraft WBC1-1). An additional termination resistor pair (enclosed within the shaded box in Figure 94) may be required between the two transformers to improve the balance between the P and M sides. The center point of this termination must be connected to ground.

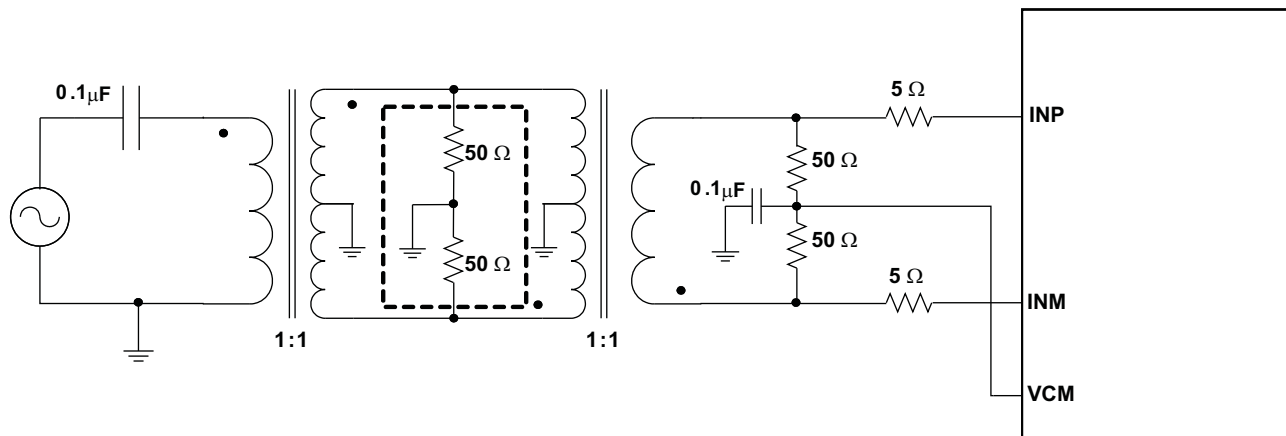

Figure 94. Two Transformer Drive Circuit

### Using Differential Amplifier Drive Circuits

Figure 95 shows a drive circuit using a differential amplifier (TI's THS4509) to convert a single-ended input to differential output that can be interface to the ADC analog input pins. In addition to the single-ended to differential conversion, the amplifier also provides gain (10 dB in Figure 95).  $R_{FIL}$  helps to isolate the amplifier outputs from the switching input of the ADC. Together with  $C_{FIL}$  it also forms a low-pass filter that band-limits the noise (and signal) at the ADC input. As the amplifier output is ac-coupled, the common-mode voltage of the ADC input pins is set using two 200  $\Omega$  resistors connected to VCM.

The amplifier output can also be dc-coupled. Using the output common-mode control of the THS4509, the ADC input pins can be biased to 1.5 V. In this case, use +4 V and -1 V supplies for the THS4509 so that its output common-mode voltage (1.5 V) is at mid-supply.

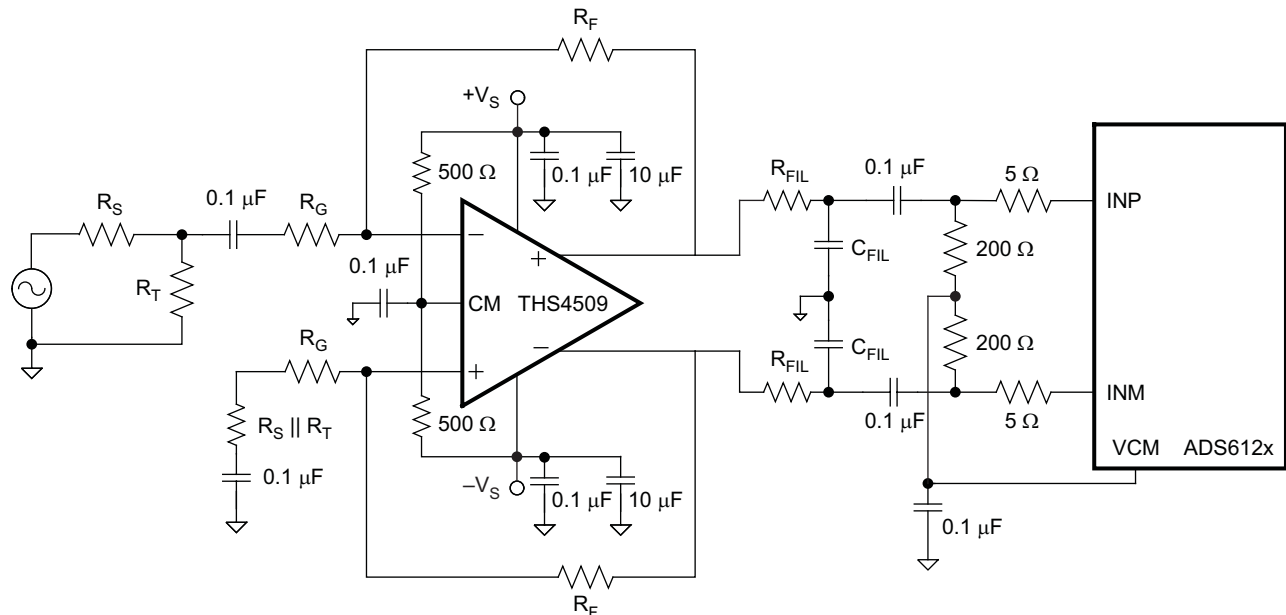

Figure 95. Drive Circuit Using the THS4509

See the EVM User Guide (SLWU028) for more information.

## Input Common-Mode

To ensure a low-noise common-mode reference, the VCM pin is filtered with a 0.1-μF low-inductance capacitor connected to ground. The VCM pin is designed to directly drive the ADC inputs. The input stage of the ADC sinks a common-mode current in the order of 180 μA (at 125 MSPS). Equation 1 describes the dependency of the common-mode current and the sampling frequency.

$$180 \mu\text{A} \times \frac{F_s}{125 \text{ MSPS}} \quad (1)$$

Equation 1 helps to design the output capability and impedance of the CM driving circuit.

## REFERENCE

ADS612X has built-in internal references REFP and REFM, requiring no external components. Design schemes are used to linearize the converter load seen by the references; this and the integration of the requisite reference capacitors on-chip eliminates the need for external decoupling. The full-scale input range of the converter is controlled in the external reference mode as explained below. The internal or external reference modes can be selected by programming the serial interface register bit <REF> (see Table 5).

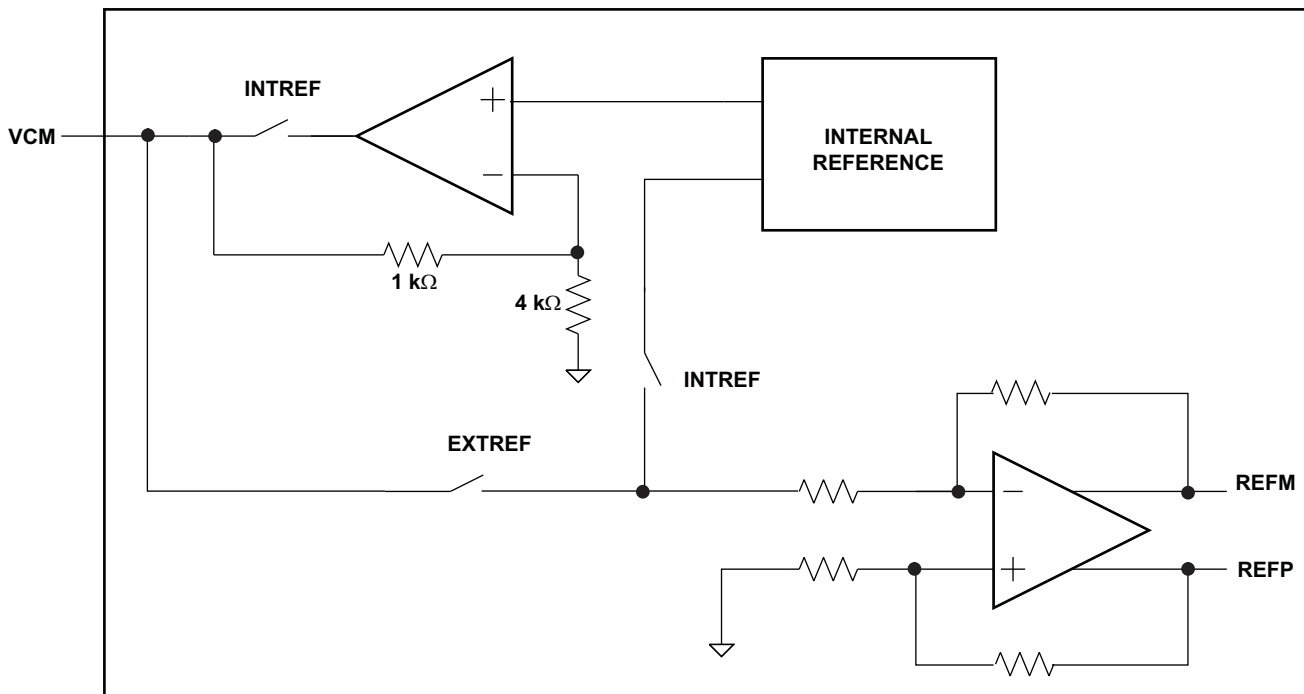

Figure 96. Reference Section

### Internal Reference

When the device is in internal reference mode, the REFP and REFM voltages are generated internally. Common-mode voltage (1.5 V nominal) is output on VCM pin, which can be used to externally bias the analog input pins.

### External Reference

When the device is in external reference mode, the VCM acts as a reference input pin. The voltage forced on the VCM pin is buffered and gained by 1.33 internally, generating the REFP and REFM voltages. The differential input voltage corresponding to full-scale is given by Equation 2.

$$\text{Full-scale differential input pp} = (\text{Voltage forced on VCM}) \times 1.33 \quad (2)$$

In this mode, the 1.5 V common-mode voltage to bias the input pins has to be generated externally. There is no change in performance compared to internal reference mode.

## COARSE GAIN and PROGRAMMABLE FINE GAIN

ADS612X includes gain settings that can be used to get improved SFDR performance (compared to 0 dB gain mode). The gain settings are 3.5 dB coarse gain and programmable fine gain from 0 dB to 6 dB. For each gain setting, the analog input full-scale range scales proportionally, as shown in [Table 15](#).

The coarse gain is a fixed setting of 3.5 dB and is designed to improve SFDR with little degradation in SNR (as seen in [Figure 13](#) and [Figure 14](#)). The fine gain is programmable in 1 dB steps from 0 to 6 dB. With fine gain also, SFDR improvement is achieved, but at the expense of SNR (there is about 1 dB SNR degradation for every 1 dB of fine gain).

So, the fine gain can be used to trade-off between SFDR and SNR. The coarse gain makes it possible to get best SFDR but without losing SNR significantly. At high input frequencies, the gains are especially useful as the SFDR improvement is significant with marginal degradation in SINAD. The gains can be programmed using the register bits <COARSE GAIN> (see [Table 5](#)) and <FINE GAIN> (see [Table 10](#)). Note that the default gain after reset is 0 dB.

**Table 15. Full-Scale Range Across Gains**

GAIN, dB	TYPE	FULL-SCALE RANGE, V <sub>PP</sub>
0	Default after reset	2.00
3.5	Coarse setting (fixed)	1.34
1	Fine gain (programmable)	1.78
2		1.59
3		1.42
4		1.26
5		1.12
6		1.00

## CLOCK INPUT

The clock inputs of the ADS612X can be driven differentially (SINE, LVPECL or LVDS) or single-ended (LVCMOS), with little or no difference in performance between configurations. The common-mode voltage of the clock inputs is set to VCM using internal 5-k $\Omega$  resistors as shown in Figure 97. This allows the use of transformer-coupled drive circuits for sine wave clock, or ac-coupling for LVPECL, LVDS clock sources (Figure 99 and Figure 100).

For best performance, it is recommended to drive the clock inputs differentially, reducing susceptibility to common-mode noise. In this case, it is best to connect both clock inputs to the differential input clock signal with 0.1- $\mu$ F capacitors, as shown in Figure 99. A single-ended CMOS clock can be ac-coupled to the CLKP input, with CLKM connected to ground with a 0.1- $\mu$ F capacitor, as shown in Figure 100.

For high input frequency sampling, the use a clock source with very low jitter is recommended. Bandpass filtering of the clock source can help reduce the effect of jitter. There is no change in performance with a non-50% duty cycle clock input. Figure 24 shows the performance of the ADC versus clock duty cycle.

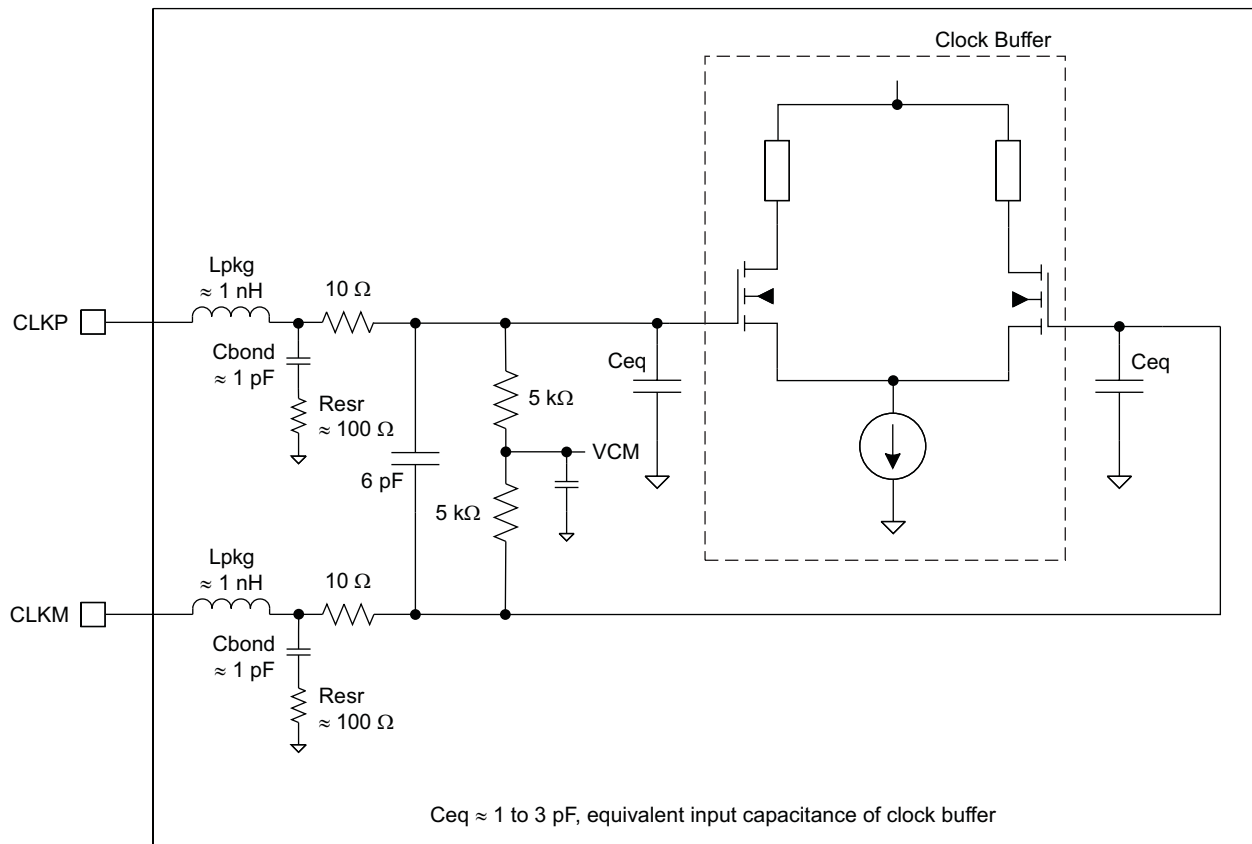
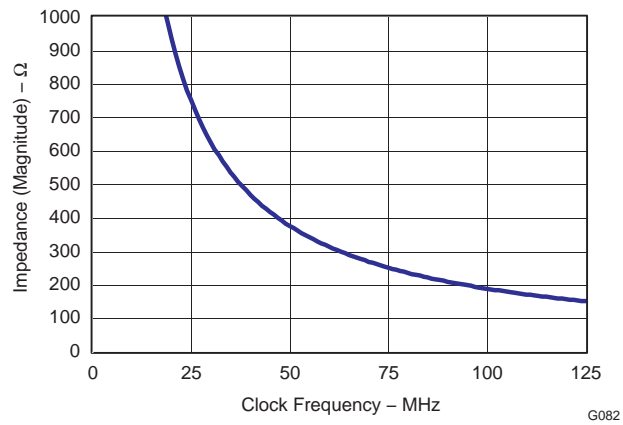
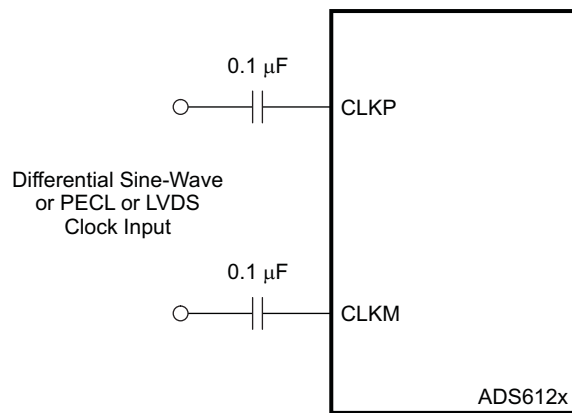

Figure 97. Internal Clock Buffer



**Figure 98. Clock Buffer Input Impedance**



**Figure 99. Differential Clock Driving Circuit**

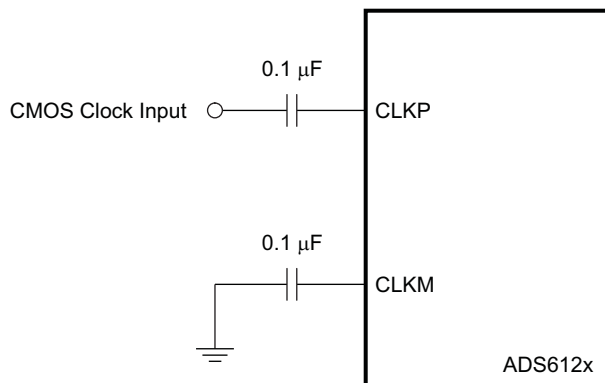

**Figure 100. Single-Ended Clock Driving Circuit**



## POWER DOWN MODES

ADS612X has four power-down modes – global power down, standby, output buffer disable and input clock stopped. These modes can be set using the serial interface or using the parallel interface (pins SDATA and PDN).

**Table 16. Power Down Modes**

POWER DOWN MODES	PARALLEL INTERFACE		SERIAL INTERFACE REGISTER BIT (Table 5)	TOTAL POWER, mW	WAKE-UP TIME (to valid data)
	SDATA	PDN			
Normal operation	Low	Low	<PDN OBUF>=0 and <STBY>=0	417	-
Standby	Low	High	<PDN OBUF>=0 and <STBY>=1	72	Slow (50 $\mu$ s)
Output buffer disable	High	Low	<PDN OBUF>=1 and <STBY>=0	408	Fast (200 ns)
Global power down	High	High	<PDN OBUF>=1 and <STBY>=1	30	Slow (50 $\mu$ s)

### Global Powerdown

In this mode, the A/D converter, internal references and the output buffers are powered down and the total power dissipation reduces to about 30 mW. The output buffers are in high impedance state. The wake-up time from the global power down to output data becoming valid in the normal mode is maximum 50  $\mu$ s. Note that after coming out of global power down, optimum performance will be achieved after the internal reference voltages have stabilized (about 1 ms).

### Standby

Here, only the A/D converter is powered down and the total power dissipation is about 72 mW. The wake-up time from standby to output data becoming valid is maximum 50  $\mu$ s.

### Output Buffer Disable

The data output buffers can be disabled, reducing the total power to about 408 mW. With the buffers disabled, the outputs are in high impedance state. The wake-up time from this mode to data becoming valid in normal mode is maximum 500 ns in LVDS mode and 200 ns in CMOS mode.

### Input Clock Stop

The converter enters this mode when the input clock frequency falls below 1 MSPS. The power dissipation is about 120 mW, and the wake-up time from this mode to data becoming valid in normal mode is maximum 50  $\mu$ s.

### Power Supply Sequence

During power-up, the AVDD and DRVDD supplies can come up in any sequence. The two supplies are separated inside the device. Externally, they can be driven from separate supplies or from a single supply.

## DIGITAL OUTPUT INTERFACE

ADS612X outputs 12 data bits together with an output clock. The output interface are either parallel CMOS or DDR LVDS voltage levels and can be selected using serial register bit **<LVDS CMOS>** or parallel pin SEN.

### Parallel CMOS Interface

In the CMOS mode, the output buffer supply (DRVDD) can be operated over a wide range from 1.8 V to 3.3 V (typical). Each data bit is output on separate pin as CMOS voltage level, every clock cycle.

For  $DRVDD \geq 2.2$  V, it is recommended to use the CMOS output clock (CLKOUT) to latch data in the receiving chip. The rising edge of CLKOUT can be used to latch data in the receiver, even at the highest sampling speed (125 MSPS). It is recommended to minimize the load capacitance seen by data and clock output pins by using short traces to the receiver. Also, match the output data and clock traces to minimize the skew between them.

For  $DRVDD < 2.2$  V, it is recommended to use external clock (for example, input clock delayed to get desired setup/hold times).

### Output Clock Position Programmability

There exists an option to shift (delay) the output clock position so that the setup time increases by 400 ps (typical, with respect to the default timings specified). This may be useful if the receiver needs more setup time, especially at high sampling frequencies. This can be programmed using the serial interface register bit **<CLKOUT\_POSN>** (see [Table 6](#)).

### Output Buffer Strength Programmability

Switching noise (caused by CMOS output data transitions) can couple into the analog inputs during the instant of sampling and degrade the SNR. The coupling and SNR degradation increases as the output buffer drive is made stronger. To minimize this, the ADS612X CMOS output buffers are designed with controlled drive strength to get best SNR. The default drive strength also ensures wide data stable window for load capacitances upto 5 pF and DRVDD supply voltage  $\geq 2.2$  V.

To ensure wide data stable window for load capacitance  $> 5$  pF, there is an option to increase the drive strength using the serial interface (**<DRIVE STRENGTH>**, see [Table 12](#)). Note that for DRVDD supply voltage  $< 2.2$  V, it is recommended to use maximum drive strength (for any value of load capacitance).

### CMOS Mode Power Dissipation

With CMOS outputs, the DRVDD current scales with the sampling frequency and the load capacitance on every output pin. The maximum DRVDD current occurs when each output bit toggles between 0 and 1 every clock cycle. In actual applications, this condition is unlikely to occur. The actual DRVDD current would be determined by the average number of output bits switching, which is a function of the sampling frequency and the nature of the analog input signal.

$$\text{Digital current due to CMOS output switching} = C_L \times DRVDD \times (N \times F_{AVG})$$

where  $C_L$  = load capacitance,  $N \times F_{AVG}$  = average number of output bits switching

[Figure 84](#) shows the current with various load capacitances across sampling frequencies at 2 MHz analog input frequency.

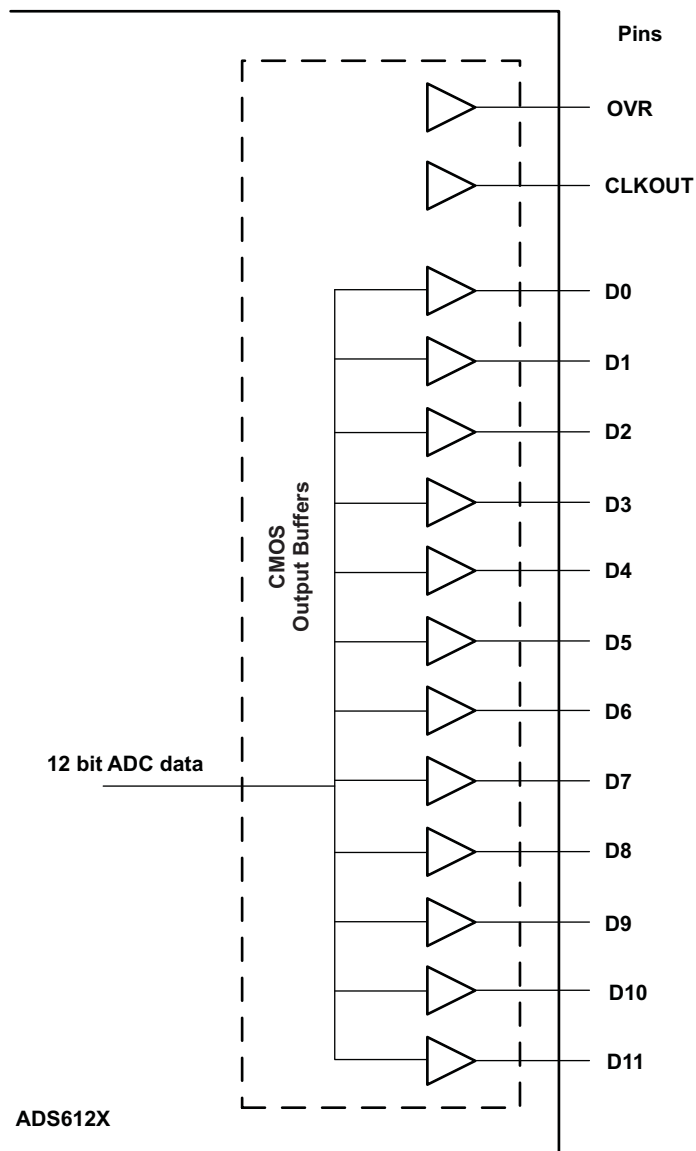

Figure 101. CMOS Output buffers

## DDR LVDS Interface

The LVDS interface works only with 3.3 V DRVDD supply. In this mode, the 12 data bits and the output clock are available as LVDS (Low Voltage Differential Signal) levels. Two successive data bits are multiplexed and output on each LVDS differential pair every clock cycle (DDR - Double Data Rate, see [Figure 102](#) ). So, there are 7 LVDS output pairs for the 12 data bits and 1 LVDS output pair for the output clock.

### LVDS Buffer Current Programmability

The default LVDS buffer output current is 3.5 mA. When terminated by 100  $\Omega$ , this results in a 350-mV single-ended voltage swing (700-mV<sub>PP</sub> differential swing). The LVDS buffer currents can also be programmed to 2.5 mA, 4.5 mA, and 1.75 mA (register bits <LVDS CURRENT>, see [Table 11](#)). In addition, there is a current double mode, where this current is doubled for the data and output clock buffers (register bits <CURRENT DOUBLE>, see [Table 11](#)).

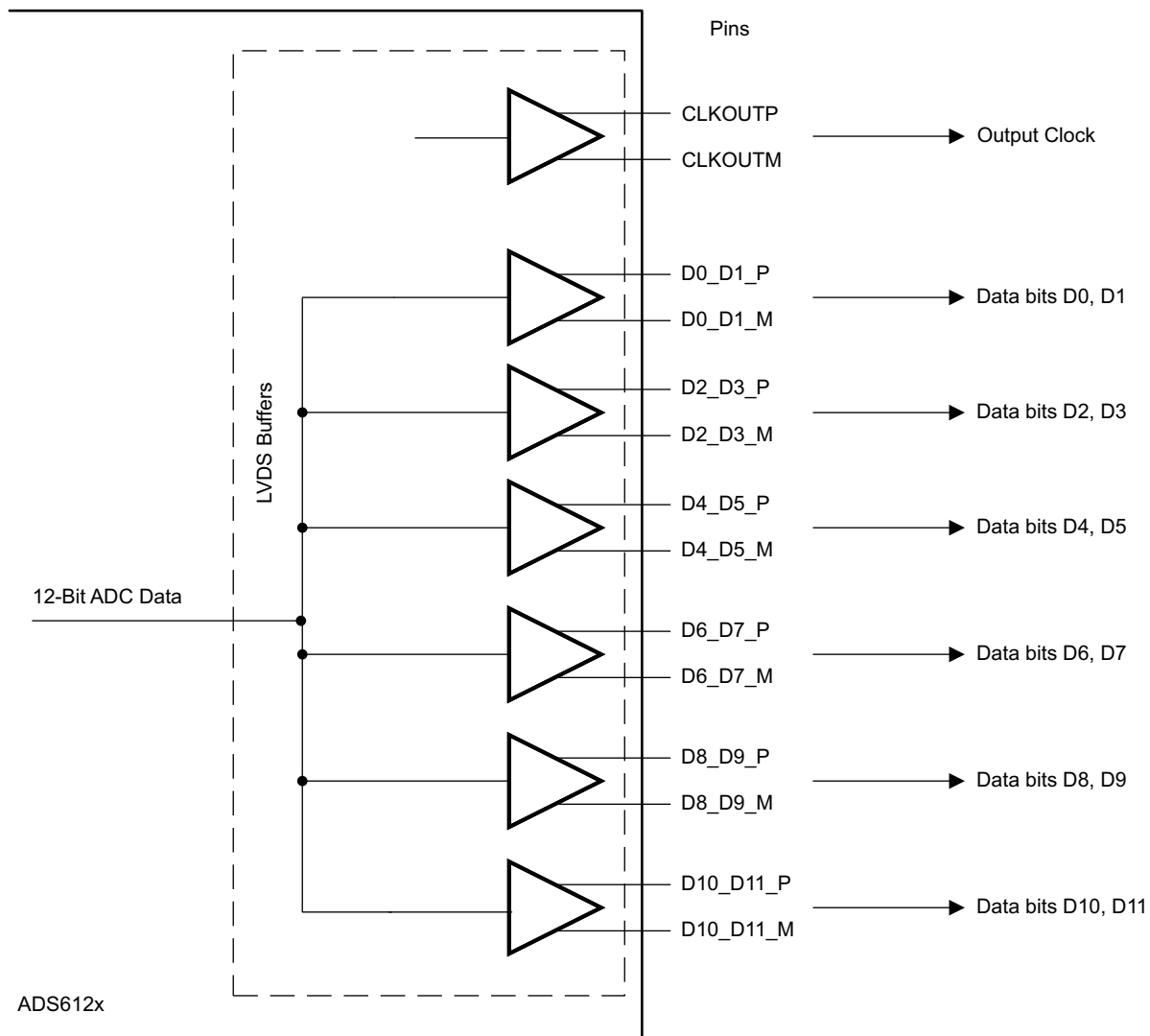
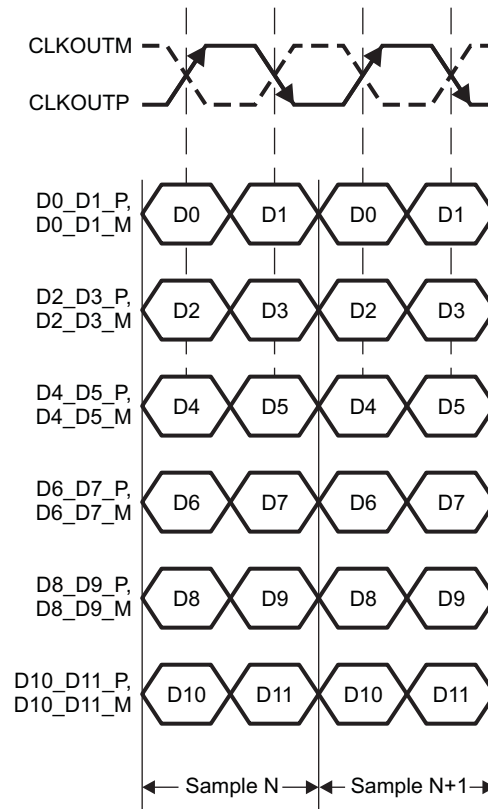

Figure 102. DDR LVDS Outputs

Even data bits D0, D2, D4, D6, D8, D10, and D12 are output at the rising edge of CLKOUTP and the odd data bits D1, D3, D5, D7, D9, D11, and D13 are output at the falling edge of CLKOUTP. Both the rising and falling edges of CLKOUTP must be used to capture all the 12 data bits (see [Figure 103](#)).



**Figure 103. DDR LVDS Interface**

### ***LVDS Buffer Internal Termination***

An internal termination option is available (using the serial interface), by which the LVDS buffers are differentially terminated inside the device. The termination resistances available are – 300  $\Omega$ , 185  $\Omega$ , and 150  $\Omega$  (nominal with  $\pm 20\%$  variation). Any combination of these three terminations can be programmed; the effective termination is the parallel combination of the selected resistances. This results in eight effective terminations from open (no termination) to 65  $\Omega$ .

The internal termination helps to absorb any reflections coming from the receiver end, improving the signal integrity. With 100  $\Omega$  internal and 100  $\Omega$  external termination, the voltage swing at the receiver end is halved (compared to no internal termination). The voltage swing can be restored by using the LVDS current double mode. [Figure 104](#) and [Figure 105](#) compare the LVDS eye diagrams without and with internal termination (100  $\Omega$ ). With internal termination, the eye looks clean even with 10 pF load capacitance (from each outpin to ground). The terminations is programmed using register bits **<DATA TERM>** and **<CLKOUT TERM>** (see [Table 11](#)).

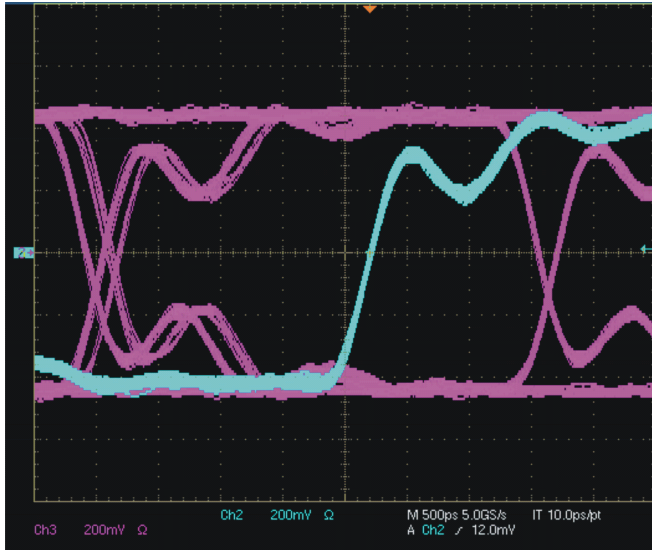

Figure 104. LVDS Eye Diagram - No Internal Termination  
5-pF Load Capacitance  
Blue Trace - Output Clock (CLKOUT)  
Pink Trace - Output Data

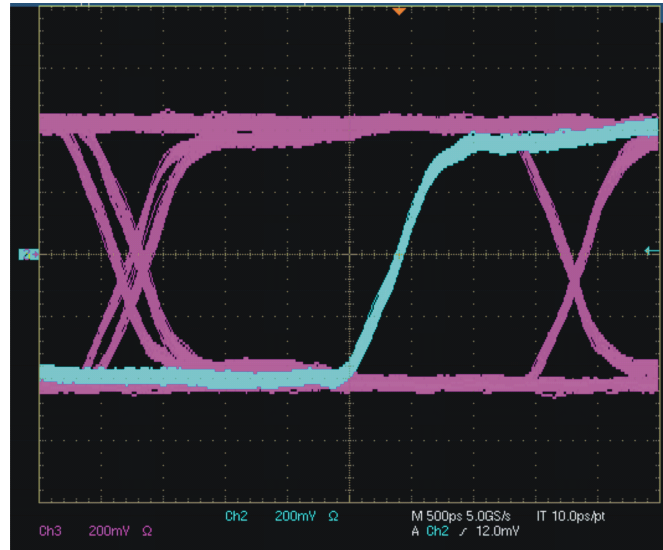

Figure 105. LVDS Eye Diagram with 100-Ω Internal Termination  
10-pF Load Capacitance  
Blue Trace - Output Clock (CLKOUT)  
Pink Trace - Output Data

### Output Data Format

Two output data formats are supported – 2s complement and offset binary. They can be selected using the parallel control pin SEN or the serial interface register bit **<DATA FORMAT>** (see [Table 8](#)).

### Output Timings

The following table lists the timings at lower sampling frequencies.

Table 17. Timing Characteristics at Lower Sampling Frequencies <sup>(1)(2)</sup>

Fs, MSPS	t <sub>SU</sub> DATA SETUP TIME, ns			t <sub>H</sub> DATA HOLD TIME, ns			t <sub>PDI</sub> CLOCK PROPAGATION DELAY, ns		
	MIN	TYP	MAX	MIN	TYP	MAX	MIN	TYP	MAX
<b>CMOS INTERFACE, DRVDD = 2.5 V to 3.3 V</b>									
40	11.3	12.8		10	11.2		5	6.5	7.9
20	23	25		21	23				
10	48	50		46	48				
<b>DDR LVDS INTERFACE, DRVDD = 3.3 V</b>									
40	10.2	10.8		0.7	1.7		4.3	5.8	7.3
20	22	23		0.7	1.7		4.5	6.5	8.5
10	47	48		0.7	1.7		4.5	6.5	8.5

(1) Timing parameters are specified by design and characterization and not tested in production.

(2) Timings are specified with default output buffer drive strength and C<sub>L</sub> = 5 pF

## BOARD DESIGN CONSIDERATIONS

### Grounding

A single ground plane is sufficient to give good performance, provided the analog, digital and clock sections of the board are cleanly partitioned. See the EVM User Guide ([SLWU028](#)) for details on layout and grounding.

### Supply Decoupling

As ADS612X already includes internal decoupling, minimal external decoupling can be used without loss in performance. Note that decoupling capacitors can help to filter external power supply noise, so the optimum number of capacitors would depend on the actual application. The decoupling capacitors should be placed very close to the converter supply pins.

It is recommended to use separate supplies for the analog and digital supply pins to isolate digital switching noise from sensitive analog circuitry. In case only a single 3.3-V supply is available, it should be routed first to AVDD. It can then be tapped and isolated with a ferrite bead (or inductor) with decoupling capacitor, before being routed to DRVDD.

### Exposed Thermal Pad

It is necessary to solder the exposed pad at the bottom of the package to a ground plane for best thermal performance. For detailed information, see application notes **QFN Layout Guidelines** ([SLOA122](#)) and **QFN/SOP PCB Attachment** ([SLUA271](#)).

## DEFINITION OF SPECIFICATIONS

### Analog Bandwidth

The analog input frequency at which the power of the fundamental is reduced by 3 dB with respect to the low frequency value.

### Aperture Delay

The delay in time between the rising edge of the input sampling clock and the actual time at which the sampling occurs.

### Aperture Uncertainty (Jitter)

The sample-to-sample variation in aperture delay.

### Clock Pulse Width/Duty Cycle

The duty cycle of a clock signal is the ratio of the time the clock signal remains at a logic high (clock pulse width) to the period of the clock signal. Duty cycle is typically expressed as a percentage. A perfect differential sine-wave clock results in a 50% duty cycle.

### Maximum Conversion Rate

The maximum sampling rate at which certified operation is given. All parametric testing is performed at this sampling rate unless otherwise noted.

### Minimum Conversion Rate

The minimum sampling rate at which the ADC functions.

### Differential Nonlinearity (DNL)

An ideal ADC exhibits code transitions at analog input values spaced exactly 1 LSB apart. The DNL is the deviation of any single step from this ideal value, measured in units of LSBs

### Integral Nonlinearity (INL)

The INL is the deviation of the ADC's transfer function from a best fit line determined by a least squares curve fit of that transfer function, measured in units of LSBs.

### Gain Error

The gain error is the deviation of the ADC's actual input full-scale range from its ideal value. The gain error is given as a percentage of the ideal input full-scale range.

### Offset Error

The offset error is the difference, given in number of LSBs, between the ADC's actual average idle channel output code and the ideal average idle channel output code. This quantity is often mapped into mV.

### Temperature Drift

The temperature drift coefficient (with respect to gain error and offset error) specifies the change per degree Celsius of the parameter from  $T_{MIN}$  to  $T_{MAX}$ . It is calculated by dividing the maximum deviation of the parameter across the  $T_{MIN}$  to  $T_{MAX}$  range by the difference  $T_{MAX}-T_{MIN}$ .



## Signal-to-Noise Ratio

SNR is the ratio of the power of the fundamental ( $P_S$ ) to the noise floor power ( $P_N$ ), excluding the power at dc and the first nine harmonics.

$$\text{SNR} = 10\text{Log}_{10} \frac{P_S}{P_N} \quad (4)$$

SNR is either given in units of dBc (dB to carrier) when the absolute power of the fundamental is used as the reference, or dBFS (dB to full scale) when the power of the fundamental is extrapolated to the converter's full-scale range.

## Signal-to-Noise and Distortion (SINAD)

SINAD is the ratio of the power of the fundamental ( $P_S$ ) to the power of all the other spectral components including noise ( $P_N$ ) and distortion ( $P_D$ ), but excluding dc.

$$\text{SINAD} = 10\text{Log}_{10} \frac{P_S}{P_N + P_D} \quad (5)$$

SINAD is either given in units of dBc (dB to carrier) when the absolute power of the fundamental is used as the reference, or dBFS (dB to full scale) when the power of the fundamental is extrapolated to the converter's full-scale range.

## Effective Number of Bits (ENOB)

The ENOB is a measure of a converter's performance as compared to the theoretical limit based on quantization noise.

$$\text{ENOB} = \frac{\text{SINAD} - 1.76}{6.02} \quad (6)$$

## Total Harmonic Distortion (THD)

THD is the ratio of the power of the fundamental ( $P_S$ ) to the power of the first nine harmonics ( $P_D$ ).

$$\text{THD} = 10\text{Log}_{10} \frac{P_S}{P_D} \quad (7)$$

THD is typically given in units of dBc (dB to carrier).

## Spurious-Free Dynamic Range (SFDR)

The ratio of the power of the fundamental to the highest other spectral component (either spur or harmonic). SFDR is typically given in units of dBc (dB to carrier).

## Two-Tone Intermodulation Distortion

IMD3 is the ratio of the power of the fundamental (at frequencies  $f_1$  and  $f_2$ ) to the power of the worst spectral component at either frequency  $2f_1 - f_2$  or  $2f_2 - f_1$ . IMD3 is either given in units of dBc (dB to carrier) when the absolute power of the fundamental is used as the reference, or dBFS (dB to full scale) when the power of the fundamental is extrapolated to the converter's full-scale range.

## DC Power Supply Rejection Ratio (DC PSRR)

The DC PSRR is the ratio of the change in offset error to a change in analog supply voltage. The DC PSRR is typically given in units of mV/V.

### AC Power Supply Rejection Ratio (AC PSRR)

AC PSRR is the measure of rejection of variations in the supply voltage of the ADC. If  $\Delta V_{\text{SUP}}$  is the change in the supply voltage and  $\Delta V_{\text{OUT}}$  is the resultant change in the ADC output code (referred to the input), then

$$\text{PSRR} = 20\text{Log}^{10} \frac{\Delta V_{\text{OUT}}}{\Delta V_{\text{SUP}}} \quad (\text{Expressed in dBc}) \quad (8)$$

### Common Mode Rejection Ratio (CMRR)

CMRR is the measure of rejection of variations in the input common-mode voltage of the ADC. If  $\Delta V_{\text{cm}}$  is the change in the input common-mode voltage and  $\Delta V_{\text{OUT}}$  is the resultant change in the ADC output code (referred to the input), then

$$\text{CMRR} = 20\text{Log}^{10} \frac{\Delta V_{\text{OUT}}}{\Delta V_{\text{CM}}} \quad (\text{Expressed in dBc}) \quad (9)$$

### Voltage Overload Recovery

The number of clock cycles taken to recover to less than 1% error for a 6-dB overload on the analog inputs. A 6-dBFS sine wave at Nyquist frequency is used as the test stimulus.

---

## REVISION HISTORY

Changes from Original (October 2007) to Revision A	Page
• Changed DDR LVDS output data sequence in <a href="#">Figure 1</a> .....	11
• Changed pin configuration (CMOS mode) information .....	21
• Changed pin configuration (LVDS mode) information .....	23

---

**PACKAGING INFORMATION**

Orderable Device	Status (1)	Package Type	Package Drawing	Pins	Package Qty	Eco Plan (2)	Lead/Ball Finish (6)	MSL Peak Temp (3)	Op Temp (°C)	Device Marking (4/5)	Samples
ADS6122IRHBT	ACTIVE	VQFN	RHB	32	250	Green (RoHS & no Sb/Br)	CU NIPDAU	Level-3-260C-168 HR	-40 to 85	AZ6122	<a href="#">Samples</a>
ADS6123IRHBT	ACTIVE	VQFN	RHB	32	250	Green (RoHS & no Sb/Br)	CU NIPDAU	Level-3-260C-168 HR	-40 to 85	AZ6123	<a href="#">Samples</a>
ADS6124IRHBR	ACTIVE	VQFN	RHB	32	3000	Green (RoHS & no Sb/Br)	CU NIPDAU	Level-3-260C-168 HR	-40 to 85	AZ6124	<a href="#">Samples</a>
ADS6124IRHBT	ACTIVE	VQFN	RHB	32	250	Green (RoHS & no Sb/Br)	CU NIPDAU	Level-3-260C-168 HR	-40 to 85	AZ6124	<a href="#">Samples</a>
ADS6125IRHBR	ACTIVE	VQFN	RHB	32	3000	Green (RoHS & no Sb/Br)	CU NIPDAU	Level-3-260C-168 HR	-40 to 85	AZ6125	<a href="#">Samples</a>
ADS6125IRHBT	ACTIVE	VQFN	RHB	32	250	Green (RoHS & no Sb/Br)	CU NIPDAU	Level-3-260C-168 HR	-40 to 85	AZ6125	<a href="#">Samples</a>

(1) The marketing status values are defined as follows:

**ACTIVE:** Product device recommended for new designs.

**LIFEBUY:** TI has announced that the device will be discontinued, and a lifetime-buy period is in effect.

**NRND:** Not recommended for new designs. Device is in production to support existing customers, but TI does not recommend using this part in a new design.

**PREVIEW:** Device has been announced but is not in production. Samples may or may not be available.

**OBSOLETE:** TI has discontinued the production of the device.

(2) Eco Plan - The planned eco-friendly classification: Pb-Free (RoHS), Pb-Free (RoHS Exempt), or Green (RoHS & no Sb/Br) - please check <http://www.ti.com/productcontent> for the latest availability information and additional product content details.

**TBD:** The Pb-Free/Green conversion plan has not been defined.

**Pb-Free (RoHS):** TI's terms "Lead-Free" or "Pb-Free" mean semiconductor products that are compatible with the current RoHS requirements for all 6 substances, including the requirement that lead not exceed 0.1% by weight in homogeneous materials. Where designed to be soldered at high temperatures, TI Pb-Free products are suitable for use in specified lead-free processes.

**Pb-Free (RoHS Exempt):** This component has a RoHS exemption for either 1) lead-based flip-chip solder bumps used between the die and package, or 2) lead-based die adhesive used between the die and leadframe. The component is otherwise considered Pb-Free (RoHS compatible) as defined above.

**Green (RoHS & no Sb/Br):** TI defines "Green" to mean Pb-Free (RoHS compatible), and free of Bromine (Br) and Antimony (Sb) based flame retardants (Br or Sb do not exceed 0.1% by weight in homogeneous material)

(3) MSL, Peak Temp. - The Moisture Sensitivity Level rating according to the JEDEC industry standard classifications, and peak solder temperature.

(4) There may be additional marking, which relates to the logo, the lot trace code information, or the environmental category on the device.

(5) Multiple Device Markings will be inside parentheses. Only one Device Marking contained in parentheses and separated by a "~" will appear on a device. If a line is indented then it is a continuation of the previous line and the two combined represent the entire Device Marking for that device.

<sup>(6)</sup> Lead/Ball Finish - Orderable Devices may have multiple material finish options. Finish options are separated by a vertical ruled line. Lead/Ball Finish values may wrap to two lines if the finish value exceeds the maximum column width.

**Important Information and Disclaimer:** The information provided on this page represents TI's knowledge and belief as of the date that it is provided. TI bases its knowledge and belief on information provided by third parties, and makes no representation or warranty as to the accuracy of such information. Efforts are underway to better integrate information from third parties. TI has taken and continues to take reasonable steps to provide representative and accurate information but may not have conducted destructive testing or chemical analysis on incoming materials and chemicals. TI and TI suppliers consider certain information to be proprietary, and thus CAS numbers and other limited information may not be available for release.

In no event shall TI's liability arising out of such information exceed the total purchase price of the TI part(s) at issue in this document sold by TI to Customer on an annual basis.

**TAPE AND REEL INFORMATION**

**QUADRANT ASSIGNMENTS FOR PIN 1 ORIENTATION IN TAPE**

\*All dimensions are nominal

Device	Package Type	Package Drawing	Pins	SPQ	Reel Diameter (mm)	Reel Width W1 (mm)	A0 (mm)	B0 (mm)	K0 (mm)	P1 (mm)	W (mm)	Pin1 Quadrant
ADS6122IRHBT	VQFN	RHB	32	250	180.0	12.4	5.3	5.3	1.5	8.0	12.0	Q2
ADS6123IRHBT	VQFN	RHB	32	250	180.0	12.4	5.3	5.3	1.5	8.0	12.0	Q2
ADS6124IRHBR	VQFN	RHB	32	3000	330.0	12.4	5.3	5.3	1.5	8.0	12.0	Q2
ADS6124IRHBT	VQFN	RHB	32	250	180.0	12.4	5.3	5.3	1.5	8.0	12.0	Q2
ADS6125IRHBR	VQFN	RHB	32	3000	330.0	12.4	5.3	5.3	1.5	8.0	12.0	Q2
ADS6125IRHBT	VQFN	RHB	32	250	180.0	12.4	5.3	5.3	1.5	8.0	12.0	Q2

**TAPE AND REEL BOX DIMENSIONS**

\*All dimensions are nominal

Device	Package Type	Package Drawing	Pins	SPQ	Length (mm)	Width (mm)	Height (mm)
ADS6122IRHBT	VQFN	RHB	32	250	210.0	185.0	35.0
ADS6123IRHBT	VQFN	RHB	32	250	210.0	185.0	35.0
ADS6124IRHBR	VQFN	RHB	32	3000	336.6	336.6	28.6
ADS6124IRHBT	VQFN	RHB	32	250	210.0	185.0	35.0
ADS6125IRHBR	VQFN	RHB	32	3000	336.6	336.6	28.6
ADS6125IRHBT	VQFN	RHB	32	250	210.0	185.0	35.0

# MECHANICAL DATA

RHB (S-PVQFN-N32)

PLASTIC QUAD FLATPACK NO-LEAD



- NOTES:
- All linear dimensions are in millimeters. Dimensioning and tolerancing per ASME Y14.5M-1994.
  - This drawing is subject to change without notice.
  - QFN (Quad Flatpack No-Lead) Package configuration.
  - The package thermal pad must be soldered to the board for thermal and mechanical performance.
  - See the additional figure in the Product Data Sheet for details regarding the exposed thermal pad features and dimensions.
  - Falls within JEDEC MO-220.



THERMAL INFORMATION

This package incorporates an exposed thermal pad that is designed to be attached directly to an external heatsink. The thermal pad must be soldered directly to the printed circuit board (PCB). After soldering, the PCB can be used as a heatsink. In addition, through the use of thermal vias, the thermal pad can be attached directly to the appropriate copper plane shown in the electrical schematic for the device, or alternatively, can be attached to a special heatsink structure designed into the PCB. This design optimizes the heat transfer from the integrated circuit (IC).

For information on the Quad Flatpack No-Lead (QFN) package and its advantages, refer to Application Report, QFN/SON PCB Attachment, Texas Instruments Literature No. SLUA271. This document is available at [www.ti.com](http://www.ti.com).

The exposed thermal pad dimensions for this package are shown in the following illustration.

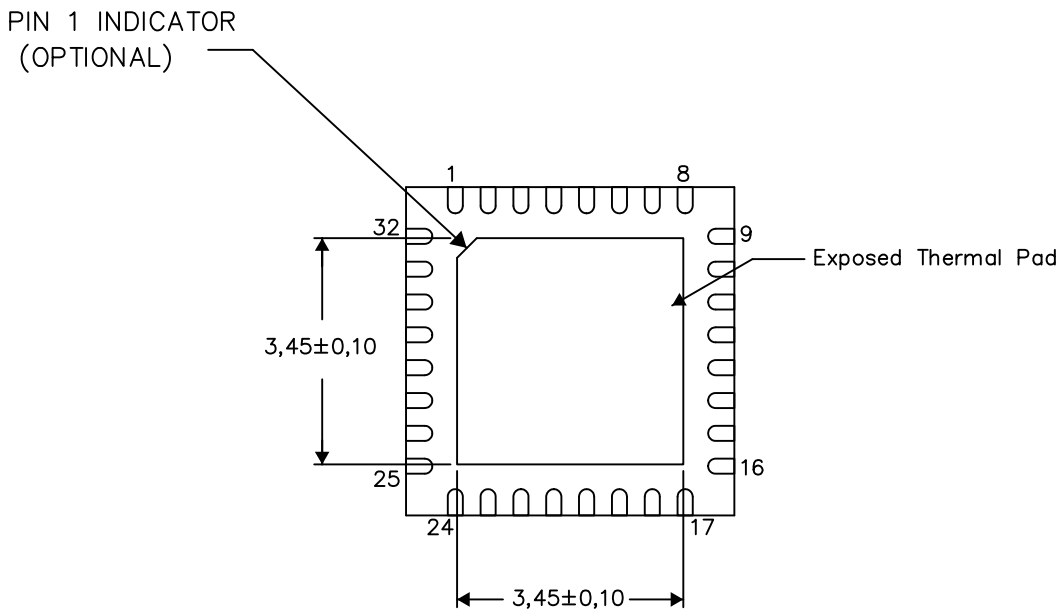

Bottom View

Exposed Thermal Pad Dimensions

4206356-2/AC 05/15

NOTE: A. All linear dimensions are in millimeters

RHB (S-PVQFN-N32)

PLASTIC QUAD FLATPACK NO-LEAD

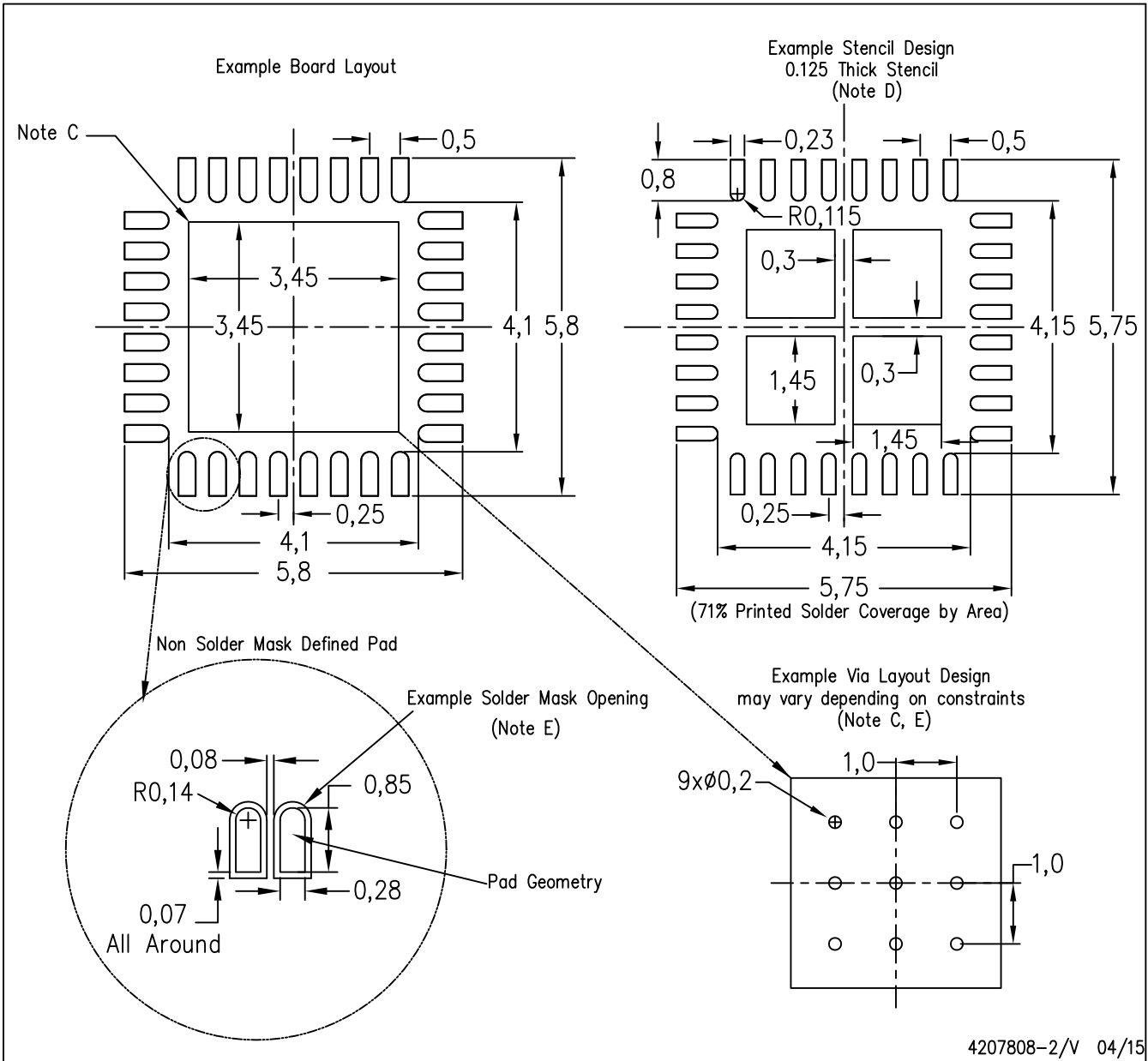

- NOTES:
- All linear dimensions are in millimeters.
  - This drawing is subject to change without notice.
  - This package is designed to be soldered to a thermal pad on the board. Refer to Application Note, Quad Flat-Pack Packages, Texas Instruments Literature No. SLUA271, and also the Product Data Sheets for specific thermal information, via requirements, and recommended board layout. These documents are available at [www.ti.com](http://www.ti.com) <<http://www.ti.com>>.
  - Laser cutting apertures with trapezoidal walls and also rounding corners will offer better paste release. Customers should contact their board assembly site for stencil design recommendations. Refer to IPC 7525 for stencil design considerations.
  - Customers should contact their board fabrication site for recommended solder mask tolerances and via tenting recommendations for any larger diameter vias placed in the thermal pad.

## IMPORTANT NOTICE

Texas Instruments Incorporated and its subsidiaries (TI) reserve the right to make corrections, enhancements, improvements and other changes to its semiconductor products and services per JESD46, latest issue, and to discontinue any product or service per JESD48, latest issue. Buyers should obtain the latest relevant information before placing orders and should verify that such information is current and complete. All semiconductor products (also referred to herein as "components") are sold subject to TI's terms and conditions of sale supplied at the time of order acknowledgment.

TI warrants performance of its components to the specifications applicable at the time of sale, in accordance with the warranty in TI's terms and conditions of sale of semiconductor products. Testing and other quality control techniques are used to the extent TI deems necessary to support this warranty. Except where mandated by applicable law, testing of all parameters of each component is not necessarily performed.

TI assumes no liability for applications assistance or the design of Buyers' products. Buyers are responsible for their products and applications using TI components. To minimize the risks associated with Buyers' products and applications, Buyers should provide adequate design and operating safeguards.

TI does not warrant or represent that any license, either express or implied, is granted under any patent right, copyright, mask work right, or other intellectual property right relating to any combination, machine, or process in which TI components or services are used. Information published by TI regarding third-party products or services does not constitute a license to use such products or services or a warranty or endorsement thereof. Use of such information may require a license from a third party under the patents or other intellectual property of the third party, or a license from TI under the patents or other intellectual property of TI.

Reproduction of significant portions of TI information in TI data books or data sheets is permissible only if reproduction is without alteration and is accompanied by all associated warranties, conditions, limitations, and notices. TI is not responsible or liable for such altered documentation. Information of third parties may be subject to additional restrictions.

Resale of TI components or services with statements different from or beyond the parameters stated by TI for that component or service voids all express and any implied warranties for the associated TI component or service and is an unfair and deceptive business practice. TI is not responsible or liable for any such statements.

Buyer acknowledges and agrees that it is solely responsible for compliance with all legal, regulatory and safety-related requirements concerning its products, and any use of TI components in its applications, notwithstanding any applications-related information or support that may be provided by TI. Buyer represents and agrees that it has all the necessary expertise to create and implement safeguards which anticipate dangerous consequences of failures, monitor failures and their consequences, lessen the likelihood of failures that might cause harm and take appropriate remedial actions. Buyer will fully indemnify TI and its representatives against any damages arising out of the use of any TI components in safety-critical applications.

In some cases, TI components may be promoted specifically to facilitate safety-related applications. With such components, TI's goal is to help enable customers to design and create their own end-product solutions that meet applicable functional safety standards and requirements. Nonetheless, such components are subject to these terms.

No TI components are authorized for use in FDA Class III (or similar life-critical medical equipment) unless authorized officers of the parties have executed a special agreement specifically governing such use.

Only those TI components which TI has specifically designated as military grade or "enhanced plastic" are designed and intended for use in military/aerospace applications or environments. Buyer acknowledges and agrees that any military or aerospace use of TI components which have **not** been so designated is solely at the Buyer's risk, and that Buyer is solely responsible for compliance with all legal and regulatory requirements in connection with such use.

TI has specifically designated certain components as meeting ISO/TS16949 requirements, mainly for automotive use. In any case of use of non-designated products, TI will not be responsible for any failure to meet ISO/TS16949.

### Products

Audio	<a href="http://www.ti.com/audio">www.ti.com/audio</a>
Amplifiers	<a href="http://amplifier.ti.com">amplifier.ti.com</a>
Data Converters	<a href="http://dataconverter.ti.com">dataconverter.ti.com</a>
DLP® Products	<a href="http://www.dlp.com">www.dlp.com</a>
DSP	<a href="http://dsp.ti.com">dsp.ti.com</a>
Clocks and Timers	<a href="http://www.ti.com/clocks">www.ti.com/clocks</a>
Interface	<a href="http://interface.ti.com">interface.ti.com</a>
Logic	<a href="http://logic.ti.com">logic.ti.com</a>
Power Mgmt	<a href="http://power.ti.com">power.ti.com</a>
Microcontrollers	<a href="http://microcontroller.ti.com">microcontroller.ti.com</a>
RFID	<a href="http://www.ti-rfid.com">www.ti-rfid.com</a>
OMAP Applications Processors	<a href="http://www.ti.com/omap">www.ti.com/omap</a>
Wireless Connectivity	<a href="http://www.ti.com/wirelessconnectivity">www.ti.com/wirelessconnectivity</a>

### Applications

Automotive and Transportation	<a href="http://www.ti.com/automotive">www.ti.com/automotive</a>
Communications and Telecom	<a href="http://www.ti.com/communications">www.ti.com/communications</a>
Computers and Peripherals	<a href="http://www.ti.com/computers">www.ti.com/computers</a>
Consumer Electronics	<a href="http://www.ti.com/consumer-apps">www.ti.com/consumer-apps</a>
Energy and Lighting	<a href="http://www.ti.com/energy">www.ti.com/energy</a>
Industrial	<a href="http://www.ti.com/industrial">www.ti.com/industrial</a>
Medical	<a href="http://www.ti.com/medical">www.ti.com/medical</a>
Security	<a href="http://www.ti.com/security">www.ti.com/security</a>
Space, Avionics and Defense	<a href="http://www.ti.com/space-avionics-defense">www.ti.com/space-avionics-defense</a>
Video and Imaging	<a href="http://www.ti.com/video">www.ti.com/video</a>

### TI E2E Community

[e2e.ti.com](http://e2e.ti.com)